

EDCON-COMPONENTS

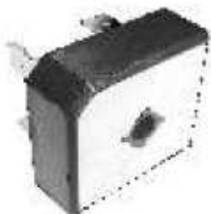

Specifications

Features

This series is UL listed under the recognized Component index file number E142814
 The plastic material used carries Underwriters Laboratory flammability recognition 94V-0
 Integrally molded heat sinks provide low thermal resistance for maximum heat dissipation
 Surge overload ratings to 300 amperes
 Universal 4-way terminals, snap-on, wrap-around, solder for P.C. Board mounting
 Molded plastic with heat sink integrally mounted in the bridge encapsulation.
 Terminals 6,3mm Faston

Weight 20gr.

Maximum Ratings & Electrical Characteristics Ratings at 25°C ambient temperature

	Sym bols	MP 15005	MP 1501	MP 1502	MP 1504	MP 1506	MP 1508	MP 1510	Unit
Maximum reccurent peak reverse Voltage	VRRM	50	100	200	400	600	800	1000	Volt
Maximum rms Input voltage	VRMS	35	70	140	280	420	560	700	Volt
Maximum dc blocking Voltage	VDC	50	100	200	400	600	800	1000	Volt
Maximum average forward output rectified TA=100°C	I(AV)	15							Amps
Peak forward surge current 8,3ms single half sine-wave	IFSM	300							Amps
Maximum forward voltage drop	VF	1,00							Volt
Maximum revese voltage TA=25°C	IR	10							µA
Maximum revese voltage TA=125°C	IR	500							µA
Operating and storage temperature range	TJ TSTG	-55°C to + 150°C							°C
I²t rating for fusing	I²t	374							A²t
Typical thermal resistance junction to case	R 0 JA	2,1							°C/W

Technical Drawing (Unit: inch(mm))

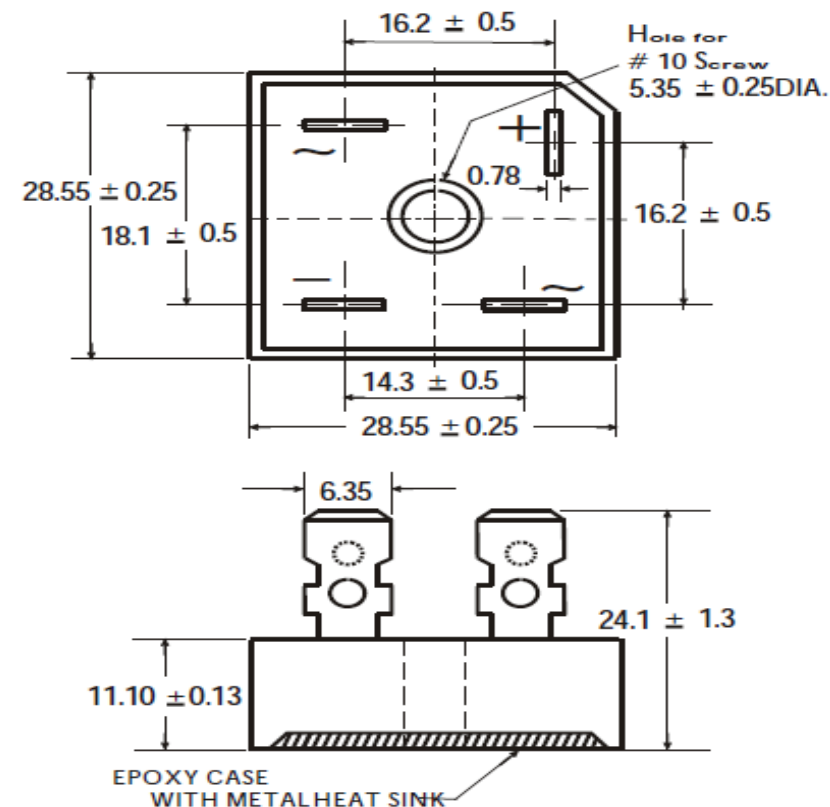

QUAD Bridge Rectifier 15A

EDCON-Ser. E17008

International Serie: MP15xx

DRW: Jason	CHKD: Wilson	MATL: Wilson	TOLERANCE: Mason	DATE: 10.05.2010
APPD: Schumi	FINISH: Jamy		Sheet No.:	1 from 5

www.edcon-components.com

email: info@edcon-components.com

EDCON-COMPONENTS



Rating & Characteristics Curves (TA=25°C unless otherwise noted)

Derating Curve for Output Rectified Current

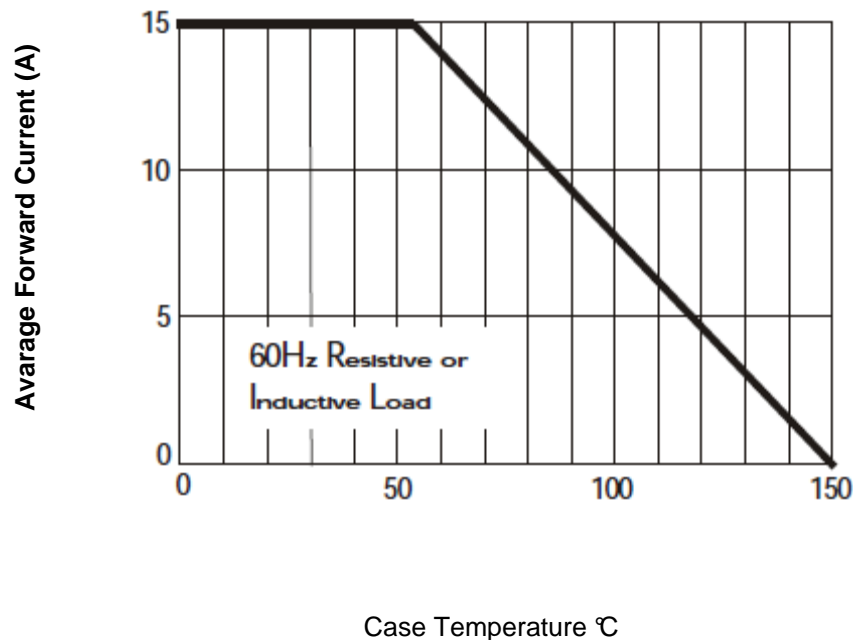

Maximum NON Repetitive Forward Surge Current

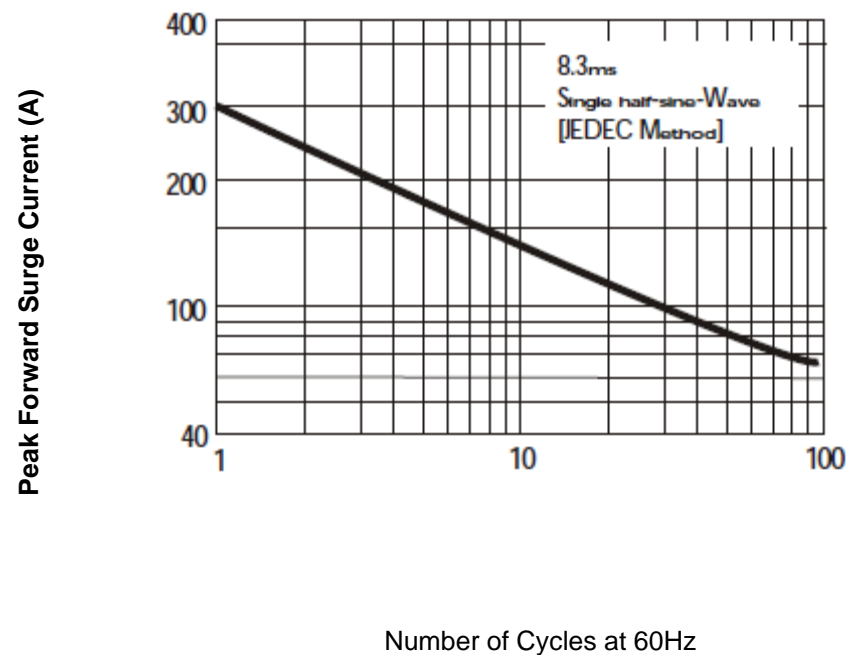

QUAD Bridge Rectifier 15A

EDCON-Ser. **E17008**

International Serie: **MP15xx**

DRW:	Jason	CHKD	Wilson	MATL:	Wilson	TOLERANCE	Mason	DATE	10.05.2010
APPD:	Schumi			FINISH	Jamy		Sheet No.	2 from 5	



Rating & Characteristics Curves (TA=25°C unless otherwise noted)

Typical Forward Characteristics

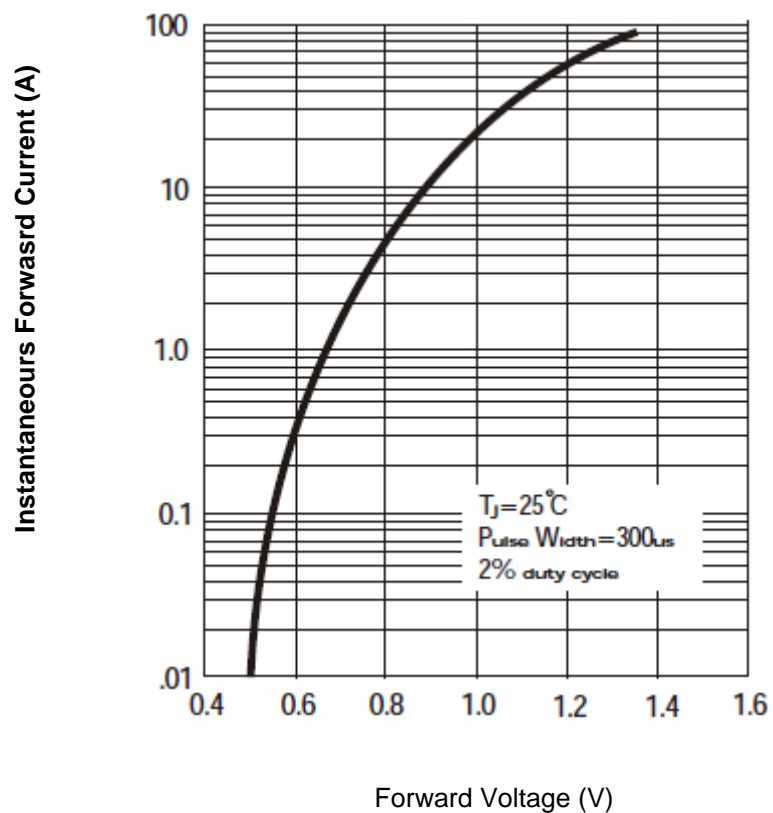

Typical Reverse Characteristics

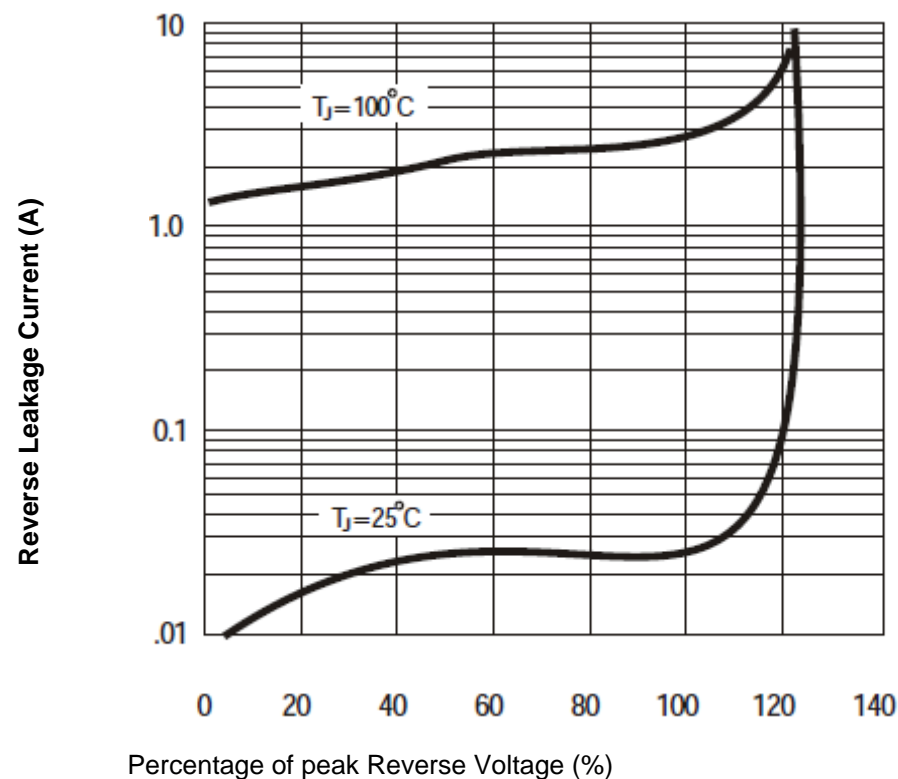

QUAD Bridge Rectifier 15A

EDCON-Ser. **E17008**

International Serie: **MP15xx**

DRW:	Jason	CHKD	Wilson	MATL:	Wilson	TOLERANCE	Mason	DATE	10.05.2010
APPD:	Schumi			FINISH	Jamy		Sheet No.	3 from 5	

EDCON-COMPONENTS

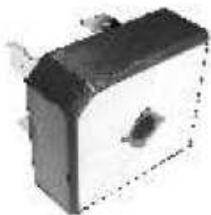

Rating & Characteristics Curves (TA=25°C unless otherwise noted)

Ordering Informations

EDCON Serie	International Type	NO function	ROHS	Package					
E17008	MP15xx	XX	R	BX					

Look Voltage Code Table		R= ROHS Conform	BX= Box
		N= NON ROHS Conform	

QUAD Bridge Rectifier 15A	
EDCON-Ser.	E17008
International Serie:	MP15xx

DRW:	Jason	CHKD	Wilson	MATL:	Wilson	TOLERANCE	Mason	DATE	10.05.2010
APPD:	Schumi			FINISH	Jamy		Sheet No.		4 from 5

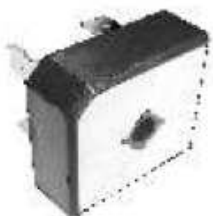

Soldering Profile Curve

Classification Reflow Profile (JEDEC J-STD-020C)



QUAD Bridge Rectifier 15A	
EDCON-Ser.	E17008
International Serie:	MP15xx

DRW:	Jason	CHKD	Wilson	MATL:	Wilson	TOLERANCE	Mason	DATE	10.05.2010
APPD:	Schumi			FINISH	Jamy		Sheet No.	5 from 5	