

EDCON-COMPONENTS

ROUND SPACER AD=21,0MM / ID=10,2MM

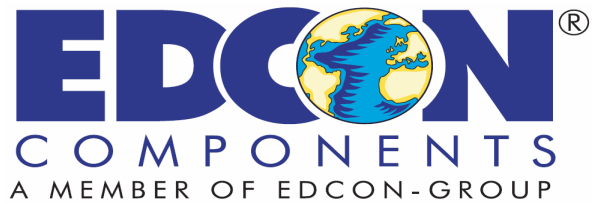

Material: Nylon 66 (UL94V-2)

Color: Natural



Dimension	OD	ID		
	21,0mm	10,2mm		

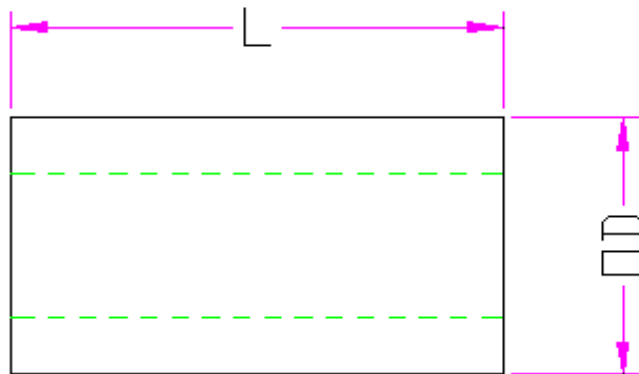
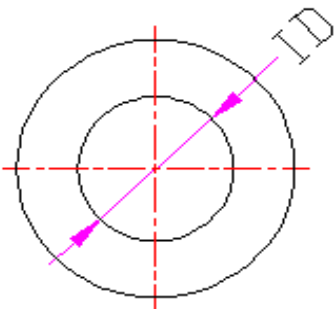

ROUND SPACER AD=21,0MM / ID=10,2MM

