

# EDCON-COMPONENTS

ROUND SPACER AD=18,0MM / ID=8,70MM



Material: Nylon 66 (UL94V-2)

Color: Natural



Dimension	OD	ID		
	18,0mm	8,70mm		

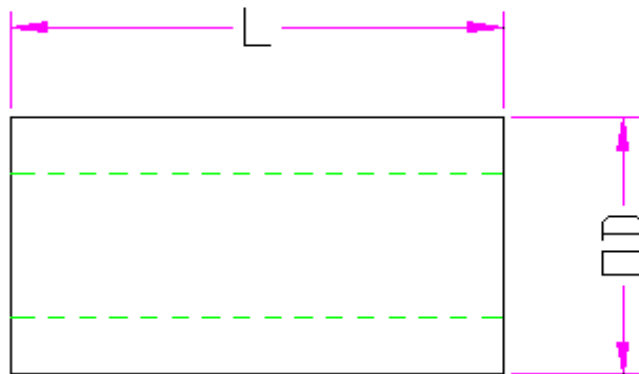
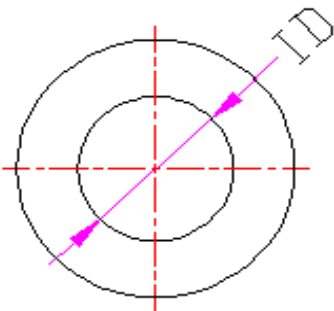

ROUND SPACER AD=18,0MM / ID=8,70MM

