

EDCON-COMPONENTS

ROUND SPACER AD=16,3MM / ID=6,50MM

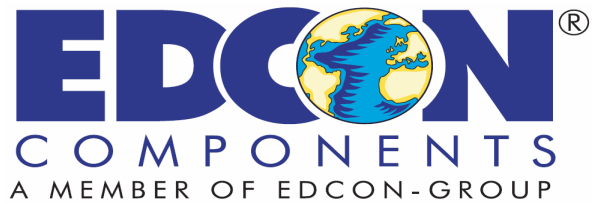

Material: Nylon 66 (UL94V-2)

Color: Natural



Dimension	OD	ID		
	16,3mm	6,5mm		

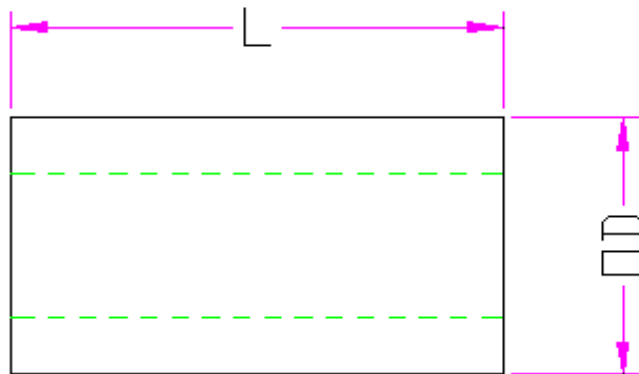
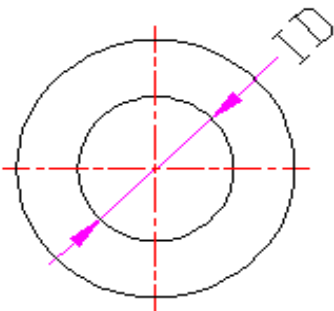

ROUND SPACER AD=16,3MM / ID=6,50MM

