

EDCON-COMPONENTS

ROUND SPACER AD=15,0MM / ID=6,2MM

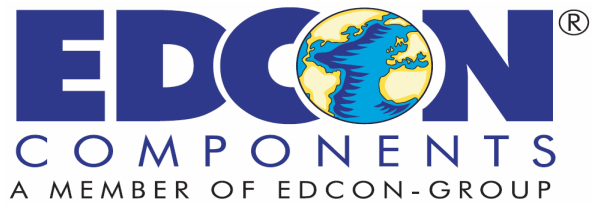
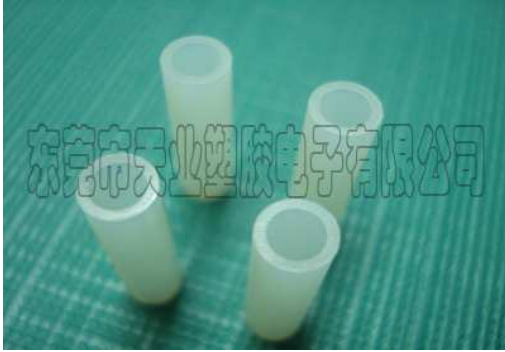

Material: Nylon 66 (UL94V-2)

Color: Natural



Dimension	OD	ID		
	15,0mm	6,2mm		

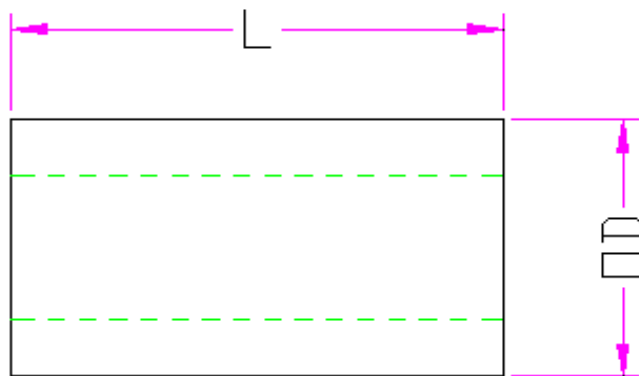
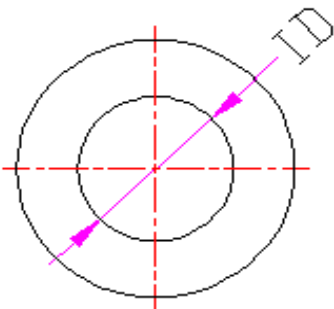

ROUND SPACER AD=15,0MM / ID=6,2MM

