

EDCON-COMPONENTS

ROUND SPACER AD=12,7MM / ID=5,0MM

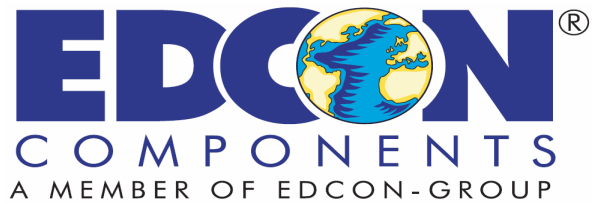
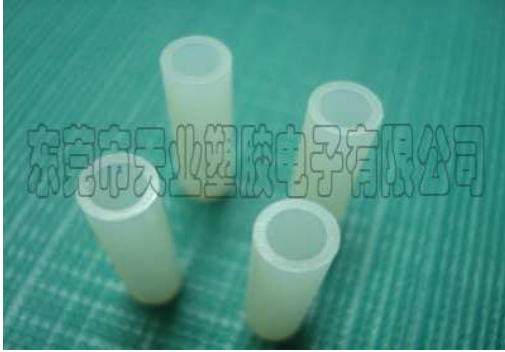

Material: Nylon 66 (UL94V-2)

Color: Natural



Dimension	OD	ID		
	12,7mm	5,0mm		

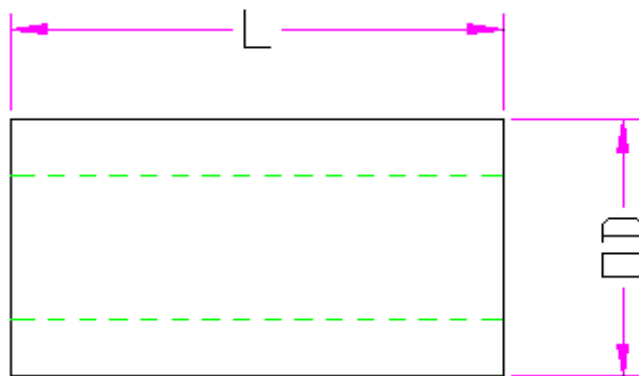
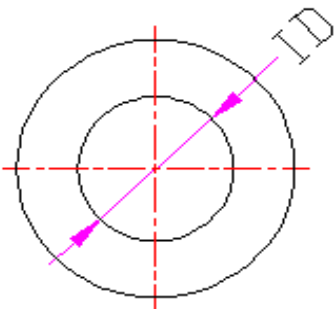

ROUND SPACER AD=12,7MM / ID=5,0MM

