

EDCON-COMPONENTS

ROUND SPACER AD=10,0MM / ID=5,2MM

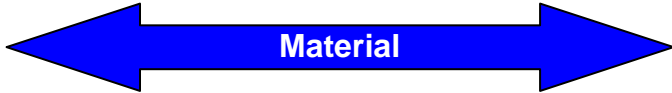
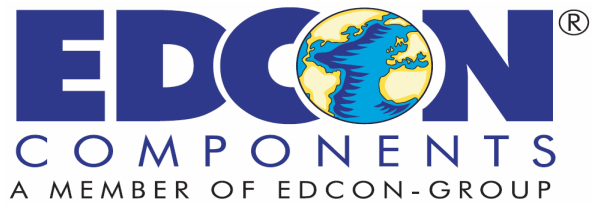

Material: Nylon 66 (UL94V-2)

Color: Natural



Dimension	OD	ID		
	10,0mm	5,2mm		

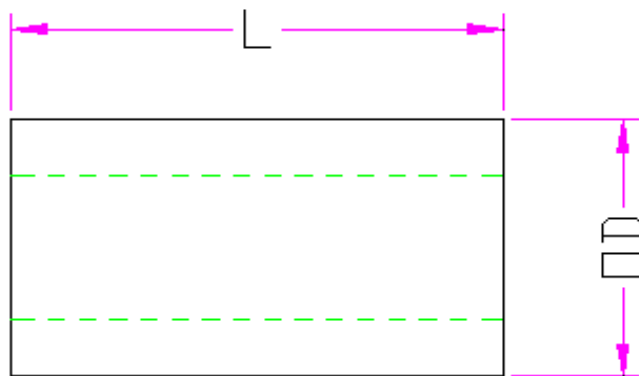
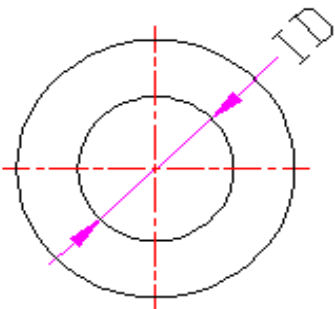

ROUND SPACER AD=10,0MM / ID=5,2MM

