

EDCON-COMPONENTS

ROUND SPACER AD=8,0MM / ID=4,1MM

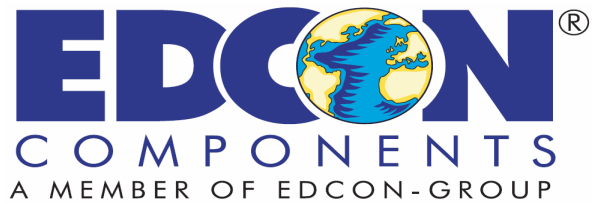

Material: Nylon 66 (UL94V-2)

Color: Natural



Dimension	OD	ID		
	8,0mm	4,1mm		

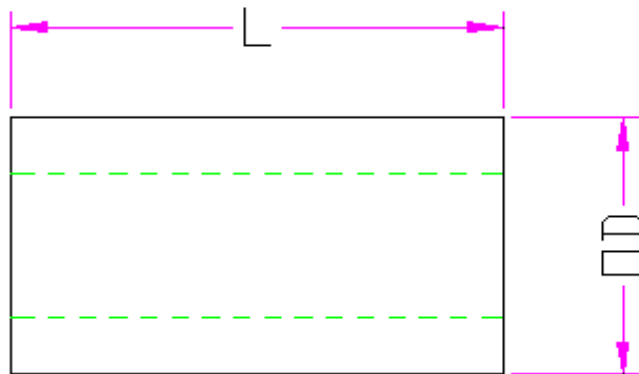
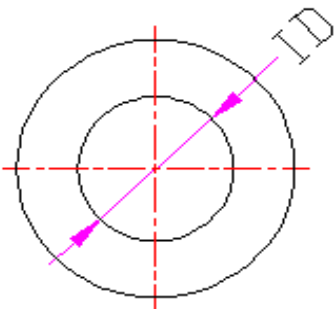

ROUND SPACER AD=8,0MM / ID=4,1MM

