

EDCON-COMPONENTS

ROUND SPACER AD=5,0MM / ID=3,5MM

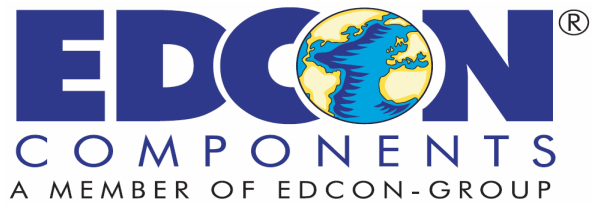

Material: Nylon 66 (UL94V-2)

Color: Natural



Dimension	OD	ID		
	5,0mm	3,5mm		

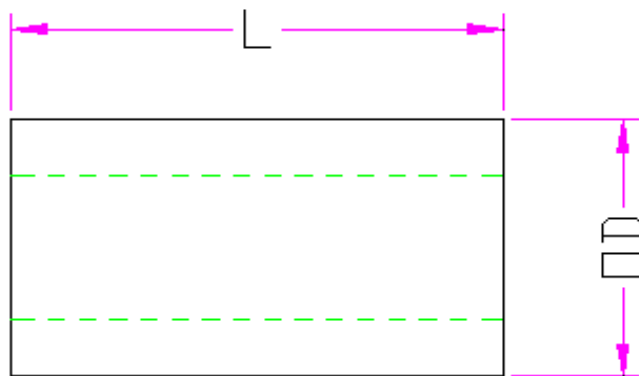
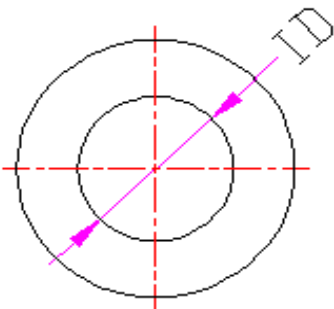

ROUND SPACER AD=5,0MM / ID=3,5MM

