

EDCON-COMPONENTS

ROUND SPACER AD=4,8MM / ID=2,8MM

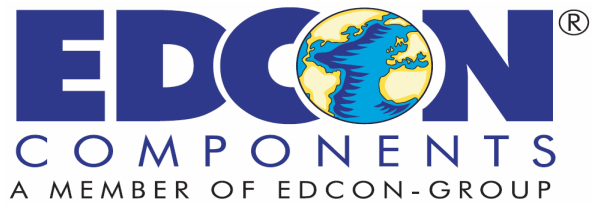
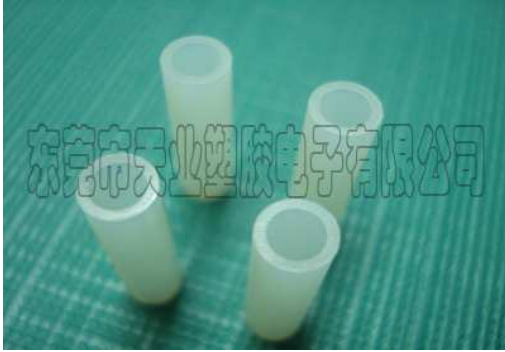

Material: Nylon 66 (UL94V-2)

Color: Natural



Dimension	OD	ID		
	4,8mm	2,8mm		

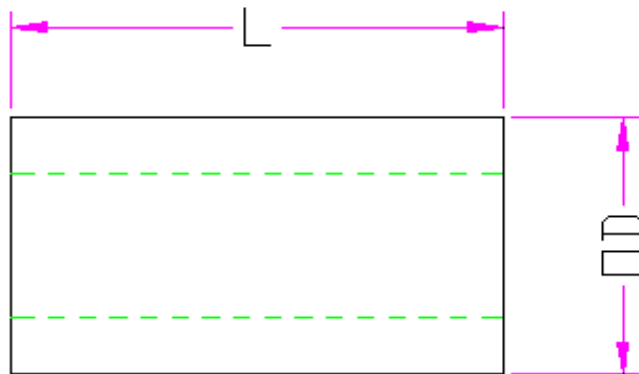
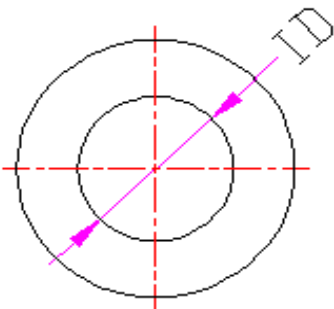

ROUND SPACER AD=4,8MM / ID=2,8MM

