

EDCON-COMPONENTS

ROUND SPACER AD=4,0MM / ID=2,8MM

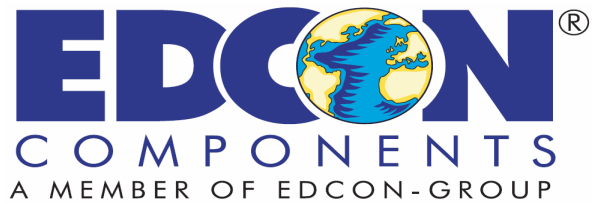

Material: Nylon 66 (UL94V-2)

Color: Natural



Dimension	OD	ID		
	4,0mm	2,8mm		

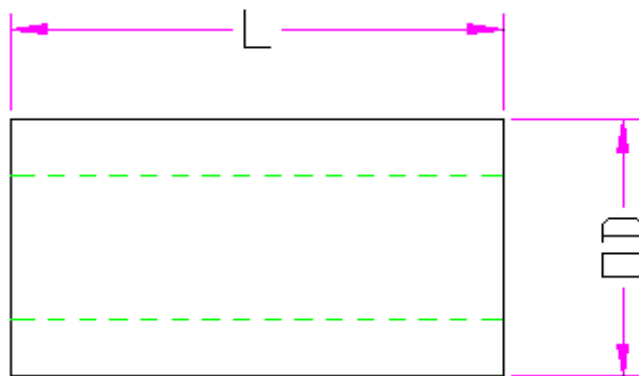
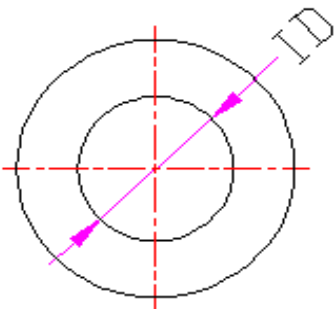

ROUND SPACER AD=4,0MM / ID=2,8MM

EDCON-COMPONENTS

ROUND SPACER AD=4,0MM / ID=2,8MM

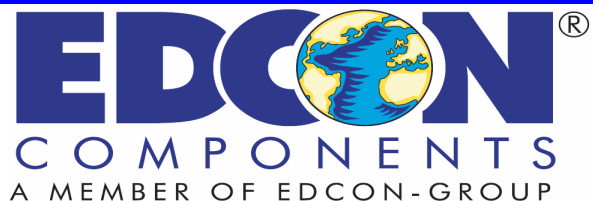

Length/mm	Code Length
3,0	030
3,5	035
4,0	040
4,5	045
5,0	050
5,5	055
6,0	060
6,5	065
7,0	070
7,5	075
8,0	080
8,5	085
9,0	090
9,5	095
10,0	100
10,5	105
11,0	110
11,5	115
12,0	120

Length/mm	Code Length
12,5	125
13,0	130
13,5	135
14,0	140
14,5	145
15,0	150
15,5	155
16,0	160
16,5	165
17,0	170
17,5	175
18,0	180
18,5	185
19,0	190
19,5	195
20,0	200

Length/mm	Code Length



Serie	Code Length	Material	Color	Packing		
N16002	030	N	N	B		
	030=3,0mm	N=Nylon	N= Natural	B=Bulk		

ROUND SPACER AD=4,0MM / ID=2,8MM