

EDCON-COMPONENTS

ROUND SPACER AD=4,0MM / ID=1,3MM

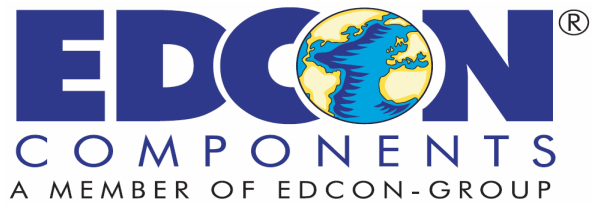

Material: Nylon 66 (UL94V-2)

Color: Natural



Dimension	OD	ID		
	4,0mm	1,3mm		

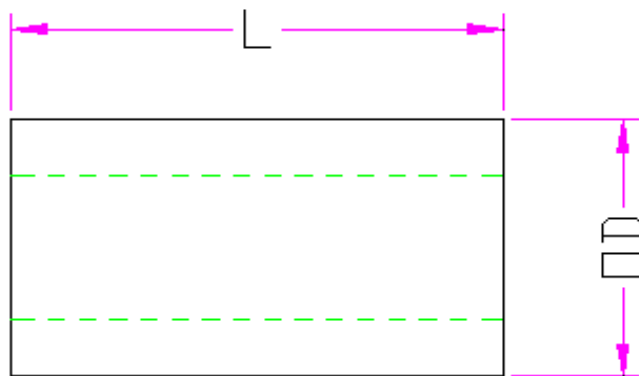
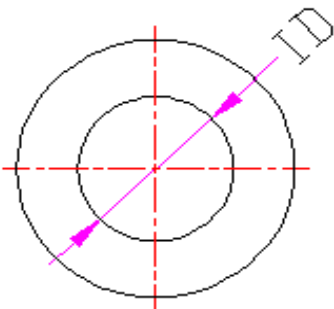

ROUND SPACER AD=4,0MM / ID=1,3MM

