

# EDCON-COMPONENTS

## LED SPACER D=5,6MM



Material: PC or Nylon 66 (UL94V-0)

Color: Natural

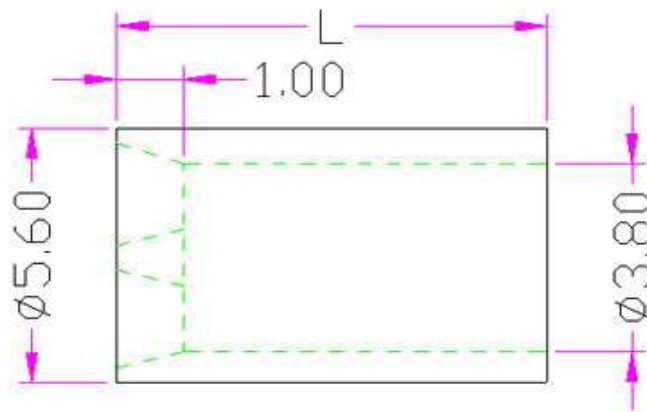
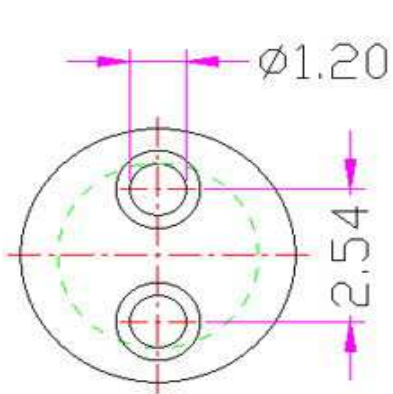

LED SPACER D=5,6MM

