

EDCON-COMPONENTS

5,0VA Standard PCB Encapsulated -Transformer

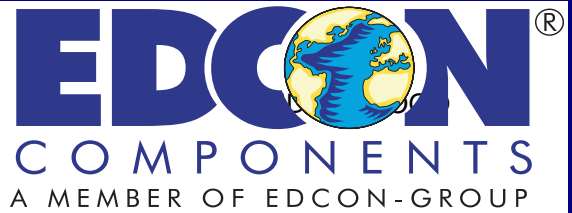

Technical specifications

Power from 0,6VA to 36VA
 Dielectric Strength - 3750 Vrms
 High ambient operation temperature (+75°C)
 Primary (115V 60HZ / 230V/50Hz)
 Secondary Single or Dual Output
 Insulation Class - Class B (130°C)
 Safety Approvals VDE / CE

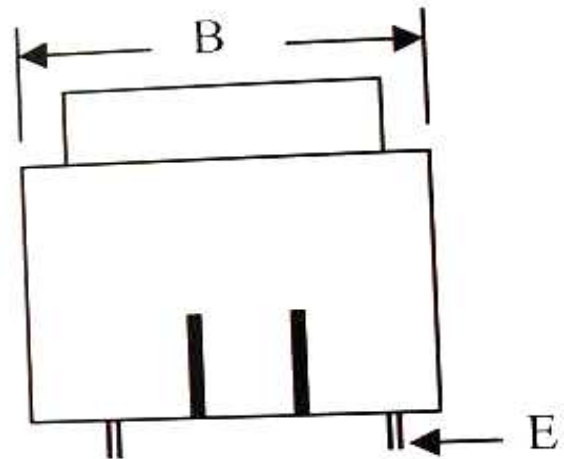

Technical drawing

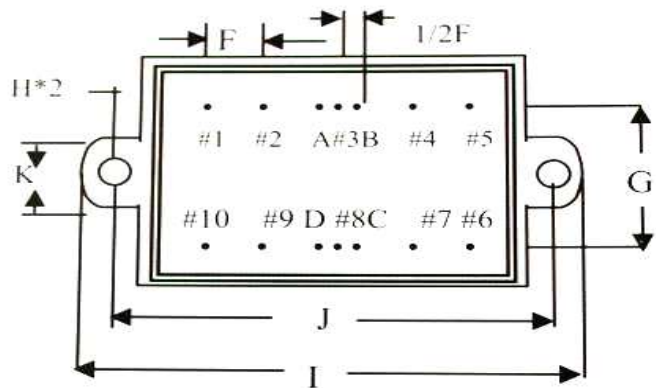
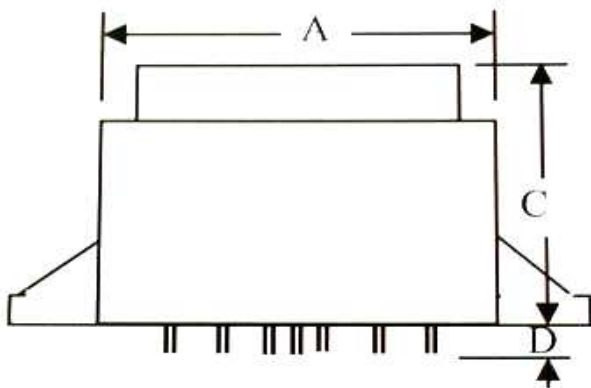

Empty pin shall be omitted if necessary.

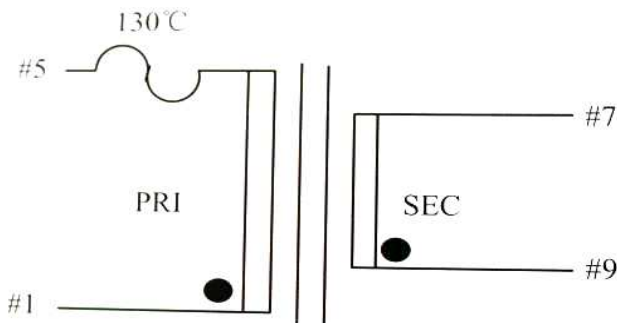

Single Output

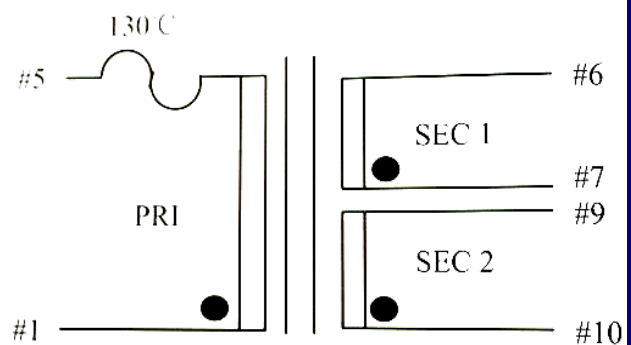

Dual Output

Standard PCB Encapsulated Transformer

EDCON-COMPONENTS

5,0VA Standard PCB Encapsulated -Transformer

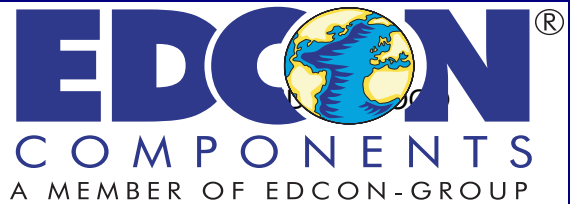

Technical dimensions

Serie	Dimensions (mm)						
	A	B	C	D	E	F	G
5,0 (VA)	45,5	38,5	33,5	4,0	0,64*0,64	5,0	25,0
Toler. (mm)	Max.	Max.	Max.	./-1,0	./-0,1	./-0,2	./-0,5
	H	I	J	K			
	4,2	64,0	55,0	10,0			
Toler. (mm)	./-0,2	Max.	./-0,5	./-0,5			

Ordering Informations

Serie	Core	Output Layer	Output Voltage	Mounting Ear
V11016	42	S	060	M

S= Single Output for 230VAC	060 = 6V 072 = 7,2V 090 = 6V 100 = 10V 120 = 12V 150 = 15V 180 = 18V 240 = 24V	Empty W/O Mounting ear
US= Single Output for 115VAC		M= with Mounting ears

6V = 833mA
 7,2V = 694mA
 9V = 555mA
 10V = 500mA
 12V = 416mA
 15V = 333mA
 18V = 277mA
 24V = 208mA

Standard PCB Encapsulated Transformer