



General

FME connectors were originally developed for the European wireless market, but have recently seen an increase in popularity globally.

Applications are in the GPS, mobile and WLAN sectors of the communications industry.

Specifications

<i>Electrical</i>		
Impedance		50 Ω
Frequency Range		0 - 3 GHz
Working Voltage		500 VRMS max.
Dielectric Withstanding Voltage		1000 VRMS min.
VSWR	Straight	1.3 max.
	Right Angle	1.5 max.
Contact Resistance	Center Contact	5 mΩ max.
	Outer Contact	2 mΩ max.
Insulator Resistance		1000 MΩ min.

<i>Material</i>		
Parts Name	Material	Finish
Body, Metal Parts	Brass per QQ-B-626	Nickel 70 micro-inches
Center Contacts	Male: Brass per QQ-B-626 Female: Phosphor Bronze per QQ-C-750	Gold 3 micro-inches Gold 3 micro-inches
Insulators	Teflon, Delrin	None
Crimp Ferrules	Annealed Brass	Nickel 70 micro-inches
Clamp Gaskets	Silicone rubber	None

Cable, Crimp FME	
Part No.:	T55Z1024
Customer:	

DRW:	Dong	CHKD	Chang		MATL:	Chui	DATE	06.05.2010
APPD:	Ping				FINISH	Hui	Sheet	1 from 2

Copyright by EDCON-COMPONENTS



Technical Drawing

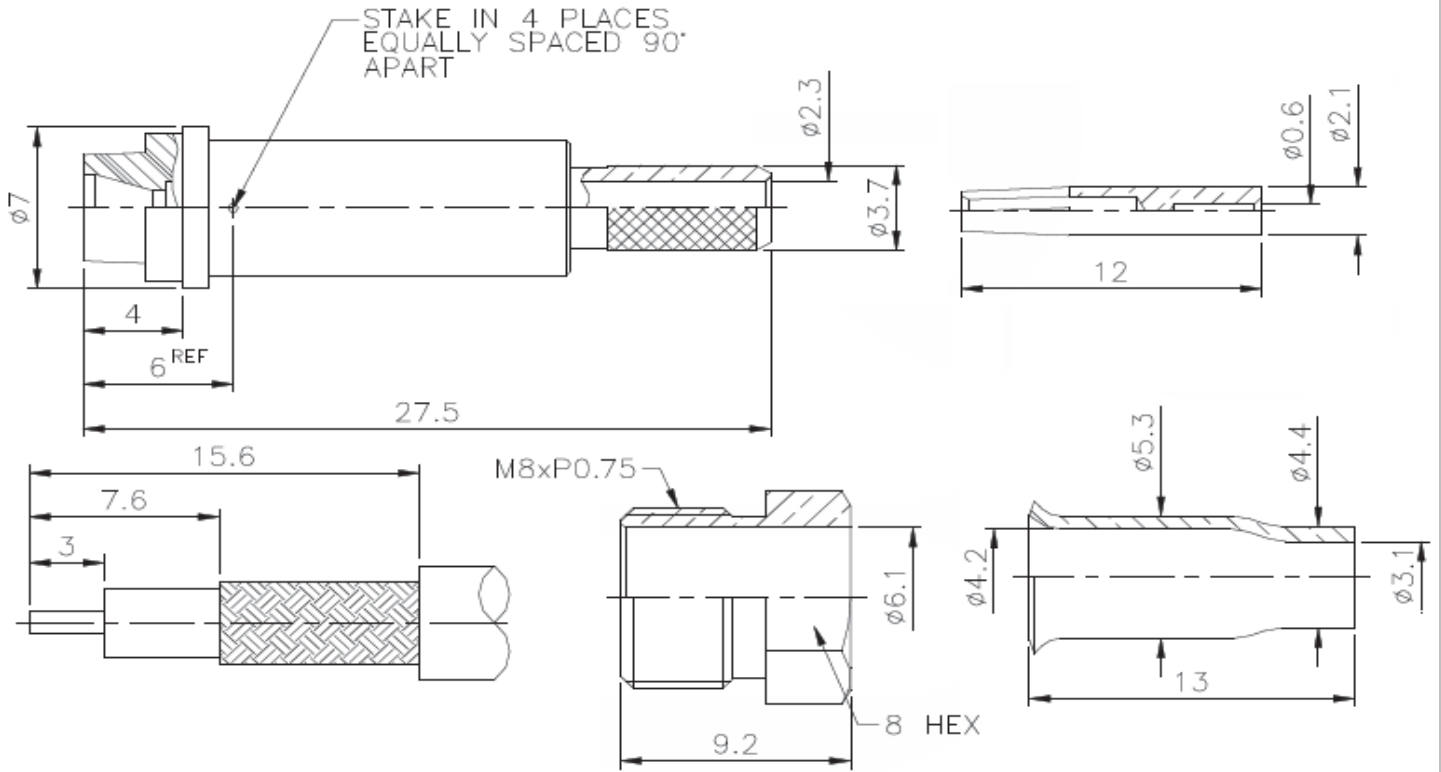

Odering Information

Serie	-	Cable Group	Impedance	No Function	RoHS	Packing
T55Z1024	-	A9	50	XX	R	BU
EDCON-Serie	-	A9 = RG-174/U, 188A/U, 316/U, LMR-100	50 = 50 Ω	XX	N = no RoHS conform R = RoHS conform	BU = Bulk Ware IV = Individual Packing

Cable, Crimp FME	
Part No.:	T55Z1024
Customer:	

DRW:	Dong	CHKD	Chang	MATL:	Chui	DATE	06.05.2010
APPD:	Ping			FINISH	Hui	Sheet	2 from 2