



General

TNC connectors are designed with a Highly reliable threaded coupling to ensure additional protection against shocks and vibrations.

They are dimensionally and electrically similar to the BNC series, and are especially suitable for use in vibration exposed equipment such as commercial and military radio telecommunication systems, as well as avionic equipment which a highly durable coupling is needed.

TNC series is also widely use in medical equipment, computer and test instrumentation.

INTERFACE MATING DIMENSIONS

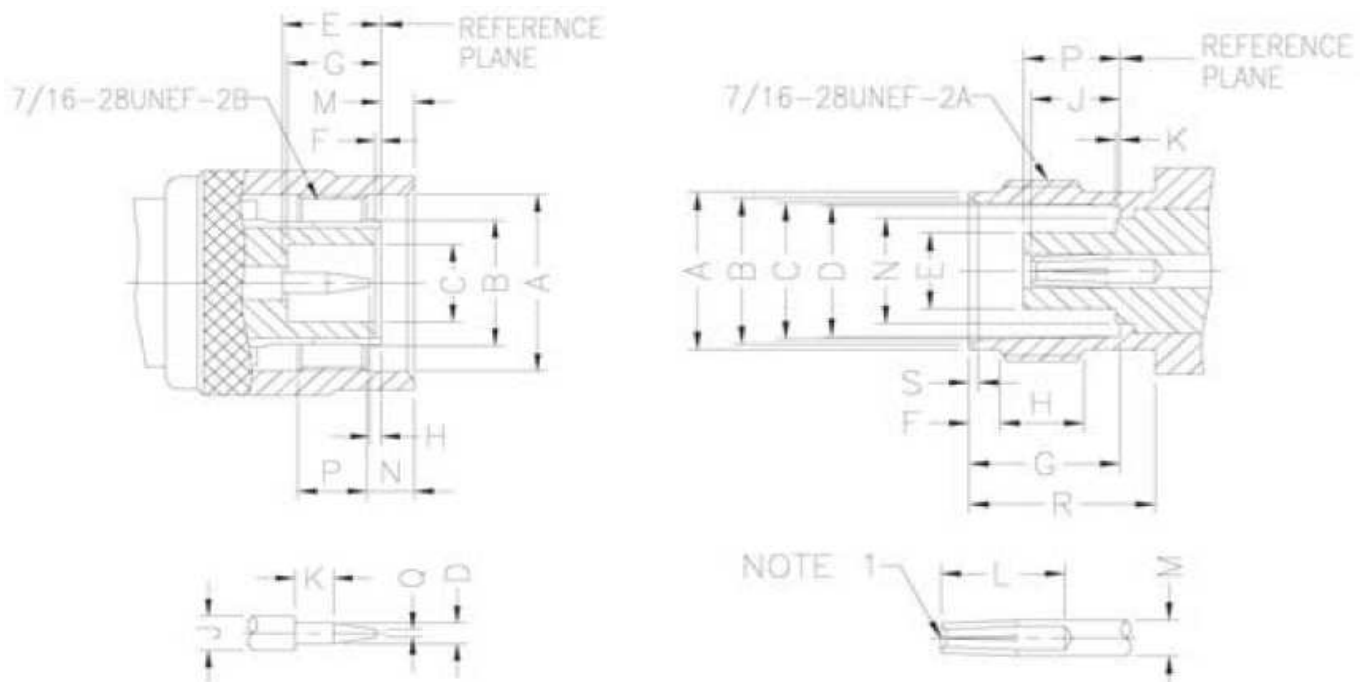

Plug					
Letter	mm		Letter	mm	
	min.	max.		min.	max.
A	11.18	---	G	5.28	5.79
B	Fleard to meet Good Electrical Contact		H	0.08	1.02
			J	2.06	2.21
			K	1.98	---
		M	---	1.98	
C	4.83	---	N	1.60	---
D	1.32	1.37	P	3.96	---
E	5.33	5.84	Q	---	0.64
F	0.15	0.46	---	---	---

Jack					
Letter	mm		Letter	mm	
	min.	max.		min.	max.
A	10.97	11.07	J	4.72	5.23
B	9.60	9.70	K	---	0.15
C	8.31	8.46	L	4.95	---
D	8.10	8.15	M	2.06	2.21
E	---	4.72	N	8.79	9.04
F	5.18	5.28	P	---	6.50
G	8.31	8.51	R	0.38	0.76
H	1.91	2.06	S	10.52	---
I	4.78	5.28	---	---	---

Note: I.D. to meet VSWR and contact resistance when mated with 1.32 / 1.37 mm Dia. Pin.

PCB Mount TNC	
Part No.:	T55T1072
Customer:	

DRW:	Dong	CHKD	Chang	MATL:	Chui	DATE	31.08.2010
APPD:	Ping			FINISH	Hui	Sheet	1 from 3



Specifications

<i>Electrical</i>			
Impedance	50 Ω	75 Ω	
Frequency Range	0 - 10 GHz	0 - 1 GHz	
Working Voltage	500 VRMS max.	500 VRMS max.	
Dielectric Withstanding Voltage	1500 VRMS min.	1500 VRMS min.	
VSWR	Straight	1.3 max.	1.3 max.
	Right Angle	1.5 max.	1.5 max.
Contact Resistance	Center Contact	3 mΩ	3 mΩ
	Outer Contact	2 mΩ	2 mΩ
Insulator Resistance	5000 MΩ min.	5000 MΩ min.	

<i>Material</i>		
Parts Name	Material	Finish
Body, Metal Parts	Brass per QQ-B-626	Nickel 70 micro-inches
Center Contacts	Male: Brass per QQ-B-626 Female: Phospor Bronze per QQ-C-750	Gold 3 micro-inches Gold 3 micro-inches
Insulators	Teflon, Delrin	None
Crimp Ferrules	Annealed Brass	Nickel 70 micro-inches
Clamp Gaskets	Silicone rubber	None

<i>Mechanical & Environmetal</i>	
Engagement Force	2 in-lbs. max.
Disengagement Force	2 in-lbs. max.
Coupling Nut Retention	100 lbs. min.
Coupling Proof Torque	15 in-lbs. min.
Contact Retention	6 lbs. min.
Durability (Mating)	500 cycles
Temperature Range	-65°C ~ 165°C
Vibration	MIL-STD-202 Method 204 Test Cond. B
Salt Spray	MIL-STD-202 Method 101 Test Cond. B
Thermal Shock	MIL-STD-202 Method 107 Test Cond. B

PCB Mount TNC	
Part No.:	T55T1072
Customer:	

DRW:	Dong	CHKD	Chang	MATL:	Chui	DATE	31.08.2010
APPD:	Ping			FINISH	Hui	Sheet	2 from 3



Technical Drawing

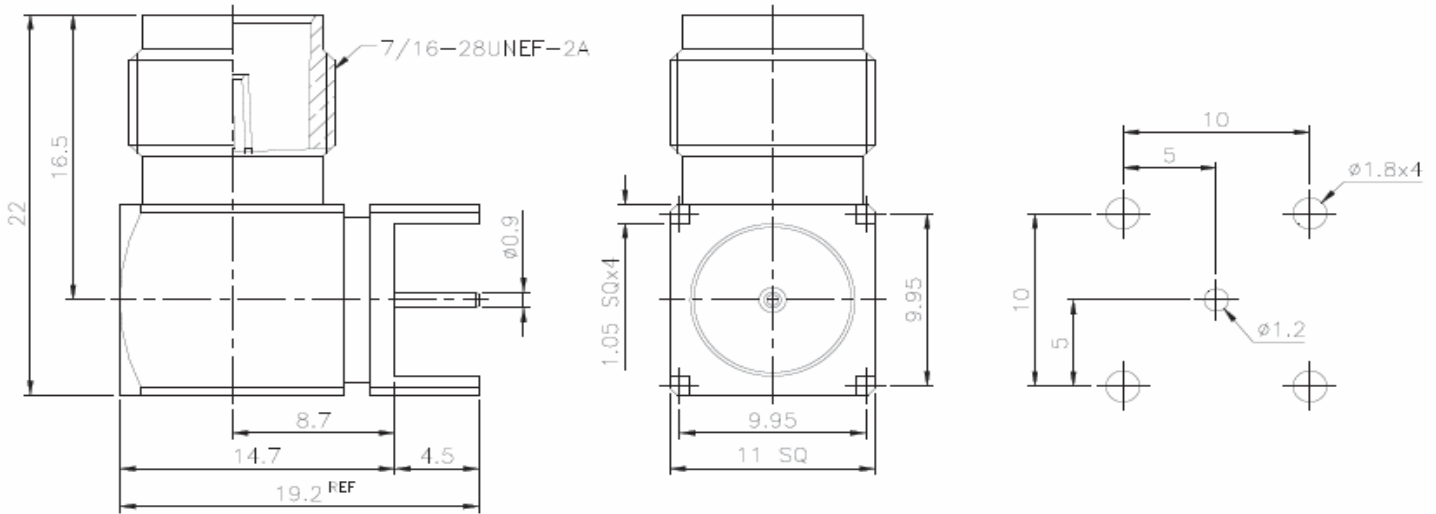

Odering Information

Serie	-	Cable Group	Impedance	No	Function	RoHS	Packing
T55T1072	-	G5	50	XX	R	BU	
EDCON-Serie	-	G5 = Blund Post	50 = 50 Ω 75 = 75 Ω	XX	N = no RoHS conform R = RoHS conform	BU = Bulk Ware IV = Individual Packing	

PCB Mount TNC	
Part No.:	T55T1072
Customer:	

DRW:	Dong	CHKD	Chang	MATL:	Chui	DATE	31.08.2010
APPD:	Ping			FINISH	Hui	Sheet	3 from 3