



**General**

SMC connectors are subminiature, lightweight connector with threaded coupling mechanism and provide excellent operation at frequency up to 10 GHz.

The screw-on mating permits a vibration-proof connection which is ideal for the use in mobile equipment with low VSWR requirements.

**INTERFACE MATING DIMENSIONS**

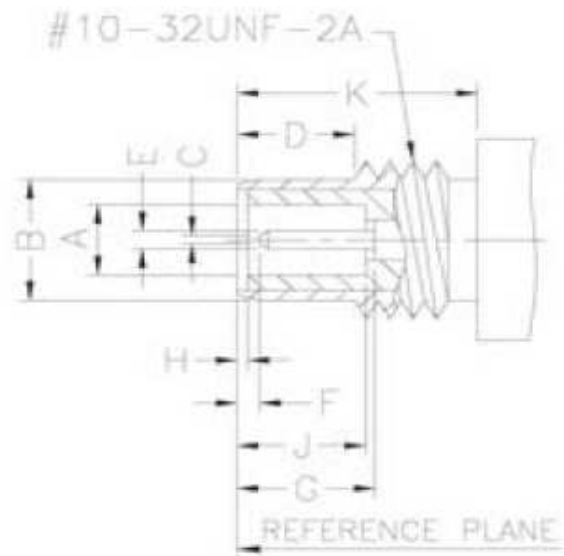
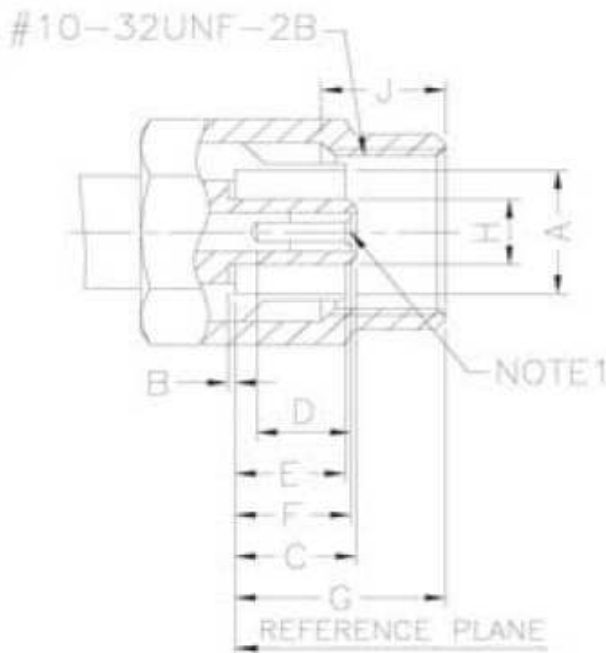

Plug		
Letter	mm	
	min.	max.
A	3.73	3.81
B	0.00	0.30
C	3.15	3.40
D	2.79	---
E	---	3.10
F	3.05	3.40
G	---	5.92
H	2.00	2.06
J	2.79	---

Jack		
Letter	mm	
	min.	max.
A	2.08	2.16
B	3.63	3.71
C	---	0.25
D	3.12	3.83
E	0.48	0.53
F	0.61	---
G	3.40	3.76
H	0.00	0.30
J	3.40	3.66
K	5.94	---

**Note:** I.D. to meet VSWR and Contact Resistance when mated with 0.48/0.53 mm dia. pin.

<b>Cable, Crimp SMC</b>	
Part No.:	<b>T55L1015</b>
Customer:	

DRW:	Dong	CHKD	Chang	MATL:	Chui	DATE	06.05.2010
APPD:	Ping			FINISH	Hui	Sheet	1 from 3



**Specifications**

<i>Electrical</i>		
Impedance		50 Ω
Frequency Range		0 - 10 GHz
Working Voltage		RG-178: 250 VRMS max. RG-316, .085": 335 VRMS max.
Dielectric Withstanding Voltage		RG-178: 750 VRMS min. RG-316, .085": 1000 VRMS min.
VSWR	Straight Right Angle	1.3 max. 1.5 max.
Contact Resistance	Center Contact Outer Contact	6 mΩ max. 2.5 mΩ max.
Insulator Resistance		1000 MΩ min.

<i>Material</i>		
Parts Name	Material	Finish
Body, Metal Parts	Brass per QQ-B-626	Gold 3 micro-inches
Center Contacts	Male: Brass per QQ-B-626 Female: Beryllium copper per QQ-C-530	Gold 30 micro-inches Gold 30 micro-inches
Insulators	Teflon	None
Crimp Ferrules	Annealed Brass	Gold 3 micro-inches

<i>Mechanical &amp; Environmental</i>	
Engagement Force	16 in-ozs. max.
Disengagement Force	16 in-ozs. max.
Coupling Nut Retention	35 lbs. min.
Coupling Proof Torque	100 in-ozs. min.
Contact Retention	4 lbs. min.
Durability (Mating)	500 cycles
Temperature Range	-65°C ~ 165°C
Vibration	MIL-STD-202 Method 204 Test Cond. B
Salt Spray	MIL-STD-202 Method 101 Test Cond. B
Thermal Shock	MIL-STD-202 Method 107 Test Cond. B

<b>Cable, Crimp SMC</b>	
Part No.:	<b>T55L1015</b>
Customer:	

DRW:	Dong	CHKD	Chang	MATL:	Chui	DATE	06.05.2010
APPD:	Ping			FINISH	Hui	Sheet	2 from 3



**Technical Drawing**

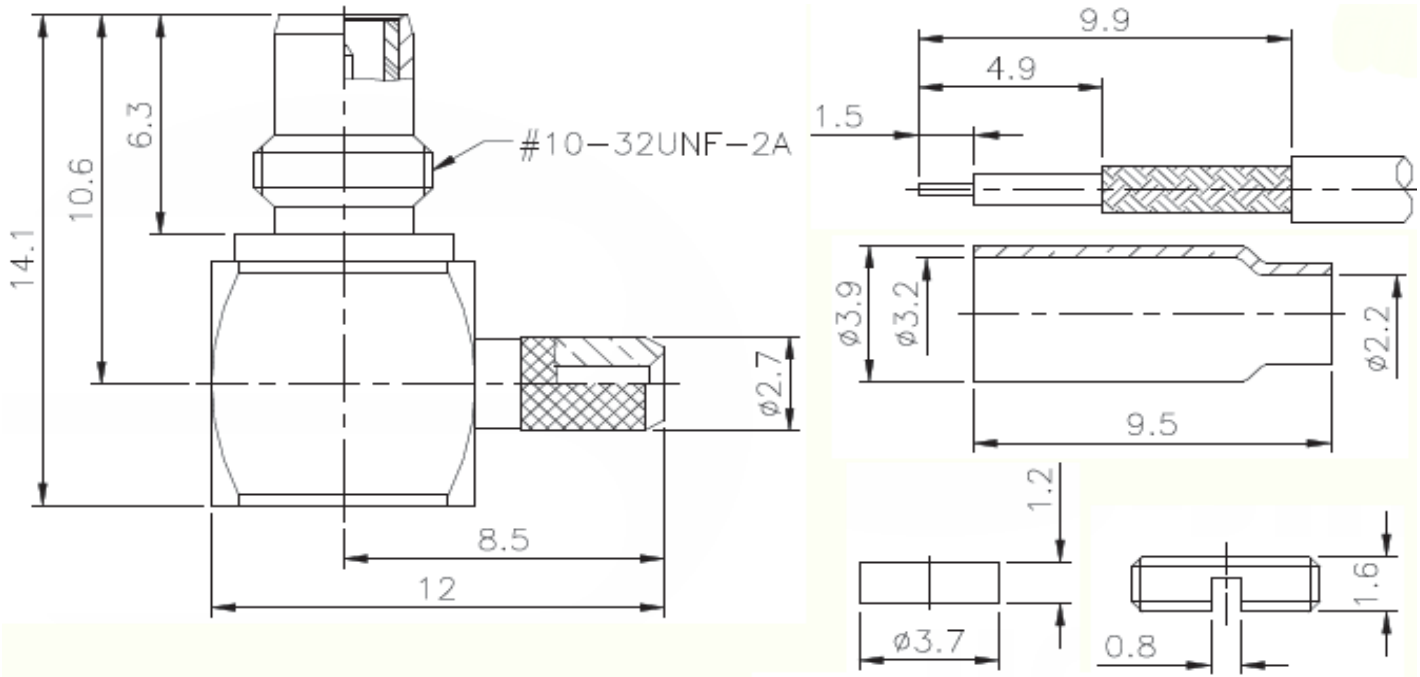

**Odering Information**

Serie	-	Cable Group	Impedance	No Function	RoHS	Packing
T55L1015	-	C8	50	XX	R	BU
EDCON-Serie	-	C8 = RG-178/U, 196/U	50 = 50 $\Omega$	XX	N = no RoHS conform R = RoHS conform	BU = Bulk Ware IV = Individual Packing

<b>Cable, Crimp SMC</b>	
Part No.:	<b>T55L1015</b>
Customer:	

DRW:	Dong	CHKD	Chang	MATL:	Chui	DATE	06.05.2010
APPD:	Ping			FINISH	Hui	Sheet	3 from 3