

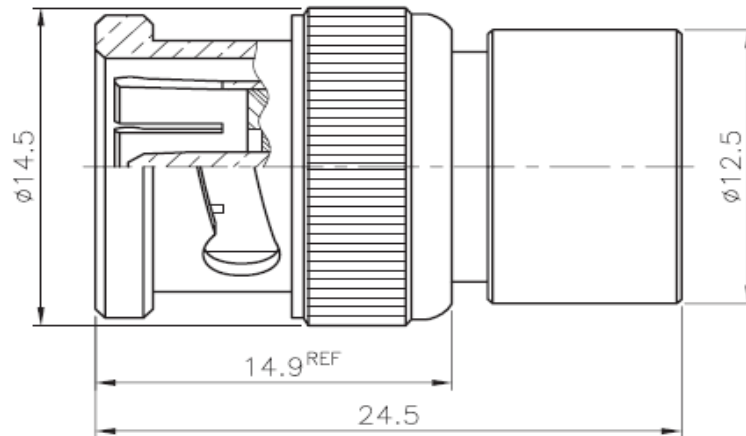

Specifications

<i>Material</i>		
Parts Name	Material	Finish
Body, Metal Parts	Brass per QQ-B-626	Nickel 70 micro-inches
Outer Contact	Brass per QQ-B-626	Gold 3 micro-inches
Center Contacts	Male: Brass per QQ-B-626 Female: Beryllium copper per QQ-C-750	Gold 3 micro-inches Gold 3 micro-inches
Insulators	Teflon	None
Crimp Ferrules	Annealed Brass	Nickel 70 micro-inches
Clamp Gaskets	Silicone rubber	None

Technical Drawing



Ordering Information

Serie	-	Cable Group	Impedance	No Function	RoHS	Packing
T55H2003	-	G4	75	XX	R	BU
EDCON-Serie	-	G4 = Others	75 = 75 Ω	XX	N = no RoHS conform R = RoHS conform	BU = Bulk Ware IV = Individual Packing

**BNC Terminators Plug
Terminators and Accessories**

Part No.: **T55H2003**

Customer:

DRW:	Dong	CHKD	Chang	MATL:	Chui	DATE	03.05.2010
APPD:	Ping			FINISH	Hui	Sheet	1 from 2