

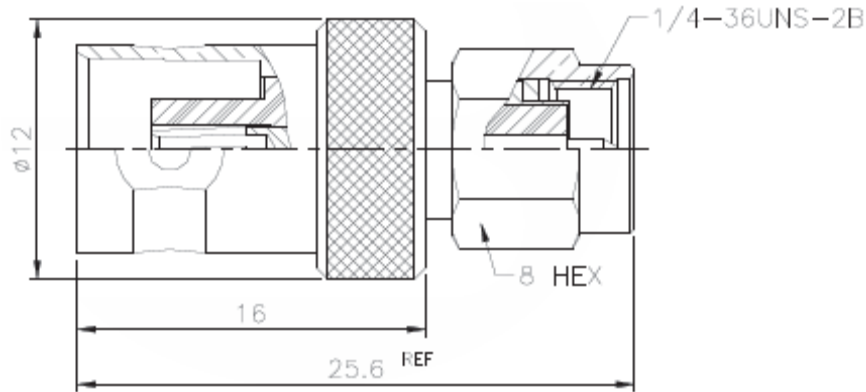

Technical Drawing



Ordering Information

Serie	-	No Function	Impedance	No Function	RoHS	Packing
T55G2047	-	XX	50	XX	R	BU
EDCON-Serie	-	XX	50 = 50 Ω	XX	N = no RoHS conform R = RoHS conform	BU = Bulk Ware IV = Individual Packing

Jack / Plug Adaptor	
Part No.:	T55G2047
Customer:	

DRW:	Dong	CHKD	Chang	MATL:	Chui	DATE	27.09.2010
APPD:	Ping			FINISH	Hui	Sheet	1 from 1