

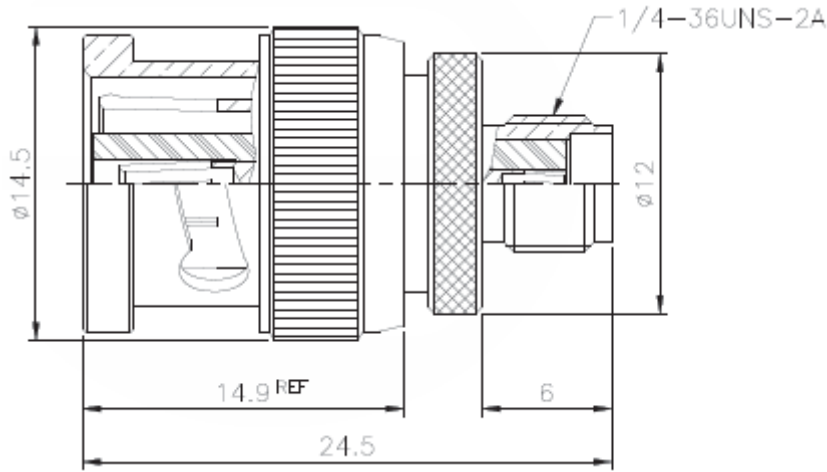

**Technical Drawing**



**Odering Information**

Serie	-	No Function	Impedance	No Function	RoHS	Packing
<b>T55G2007</b>	-	<b>XX</b>	<b>50</b>	<b>XX</b>	<b>R</b>	<b>BU</b>
EDCON-Serie	-	XX	50 = 50 Ω	XX	N = no RoHS conform  R = RoHS conform	BU = Bulk Ware  IV = Individual Packing

<b>Plug / Jack Adaptor</b>	
Part No.:	<b>T55G2007</b>
Customer:	

DRW:	Dong	CHKD	Chang	MATL:	Chui	DATE	27.09.2010
APPD:	Ping			FINISH	Hui	Sheet	1 from 1