

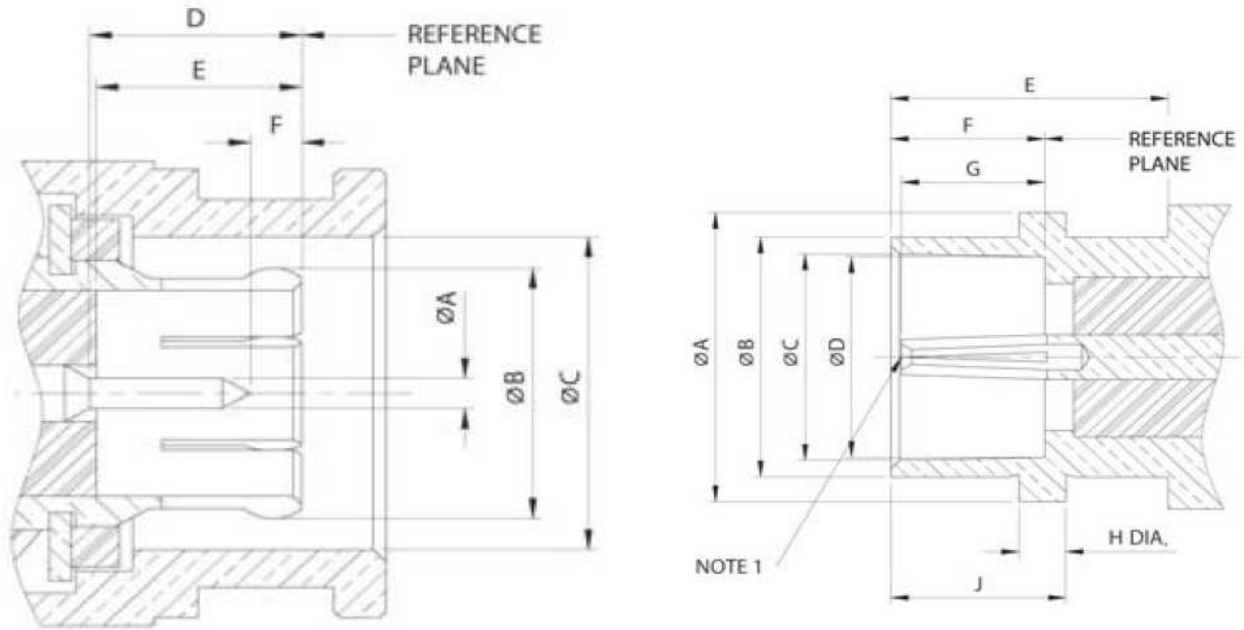

General

Preserving the positive advantage of a bayonet coupling mechanism, Mini BNC operates in a frequency range up to 2 GHz and fit to 75 Ω systems. The Mini BNC connectors, allowing for quicker connection and disconnection, are suitable for telecommunication and broadband for higher connector densities.

INTERFACE MATING DIMENSIONS



Plug		
Letter	mm	
	min.	max.
A	0.72	0.76
B	FLARED TO MEET GOOD ELECTRICAL CONTACT	
C	7.70	7.80
D	4.55	5.05
E	4.55	4.85
F	0.92	1.42

Jack		
Letter	mm	
	min.	max.
A	8.89	9.14
B	7.44	7.54
C	6.40	6.50
D	6.22	6.32
E	7.70	---
F	4.35	4.55
G	3.85	4.35
H	1.27	1.43
J	4.96	5.10

Note: I.D. to meet VSWR and Contact Resistance when mated with 0.35/0.38 mm dia. pin.

Cable, Crimp MINI BNC	
Part No.:	T55F1001
Customer:	

DRW:	Dong	CHKD	Chang	MATL:	Chui	DATE	28.04.2010
APPD:	Ping			FINISH	Hui	Sheet	1 from 3



Specifications

<i>Electrical</i>		
Impedance	75 Ω	
Frequency Range	0 - 2 GHz	
Working Voltage	300 VRMS max.	
Dielectric Withstanding Voltage	1000 VRMS max.	
VSWR	Straight	1.1 max. to 500 MHz
	Right Angle	1.16 max. to 1 GHz
Contact Resistance	Center Contact	12 mΩ max.
	Outer Contact	3 mΩ max.
Insulator Resistance	1000 MΩ min.	

<i>Material</i>		
Parts Name	Material	Finish
Body, Metal Parts	Brass per QQ-B-626	Nickel 70 micro-inches
Center Contacts	Male: Brass per QQ-B-626 Female: Phosphor Bronze per QQ-C-530	Gold 3 micro-inches Gold 3 micro-inches
Insulators	Teflon	None
Crimp Ferrules	Annealed Brass	Nickel 70 micro-inches

<i>Mechanical & Environmental</i>	
Engagement Force	2.5 in-lbs. max. torque
Disengagement Force	3 lbs. max. axial force
Coupling Nut Retention	40 lbs. min.
Contact Retention	4 lbs. min.
Durability (Mating)	500 cycles
Temperature Range	-40°C ~ 85°C
Vibration	MIL-STD-202 Method 204 Test Cond. B
Salt Spray	MIL-STD-202 Method 101 Test Cond. B
Thermal Shock	MIL-STD-202 Method 107 Test Cond. B

**Cable, Crimp
 MINI BNC**

Part No.: **T55F1001**

Customer:

DRW:	Dong	CHKD	Chang	MATL:	Chui	DATE	28.04.2010
APPD:	Ping			FINISH	Hui	Sheet	2 from 3



Technical Drawing

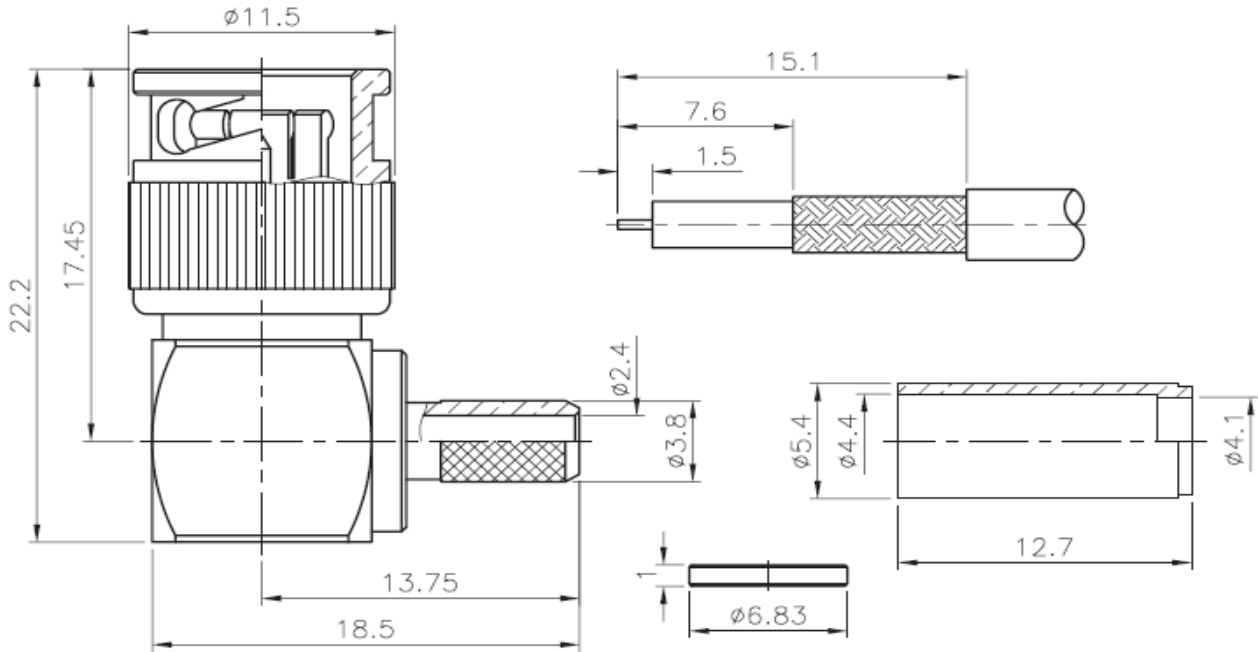

Odering Information

Serie	-	Cable Group	Impedance	No Function	RoHS	Packing
T55F1001	-	E6	75	XX	R	BU
EDCON-Serie	-	E6 = 735A	75 = 75 Ω	XX	N = no RoHS conform R = RoHS conform	BU = Bulk Ware IV = Individual Packing

Cable, Crimp MINI BNC	
Part No.:	T55F1001
Customer:	

DRW:	Dong	CHKD	Chang	MATL:	Chui	DATE	28.04.2010
APPD:	Ping			FINISH	Hui	Sheet	3 from 3