



General

EDCON develops SMP series to fulfill customer's demands for higher-frequency and miniaturized connectors. These are easy snap-on connectors; Operatable up to 40GHz.

These SMP connectors are ideal for board to board interconnections by joining plugs on different boards with a jack-to-jack adaptor in between.

SMP interface provides three different levels of retention force: full detent, limited detent, and smooth bore. Full detent is often used for connections with highest retention, limited detent is only for retaining the bullet, and smooth bore is for the lowest retention.

INTERFACE MATING DIMENSIONS

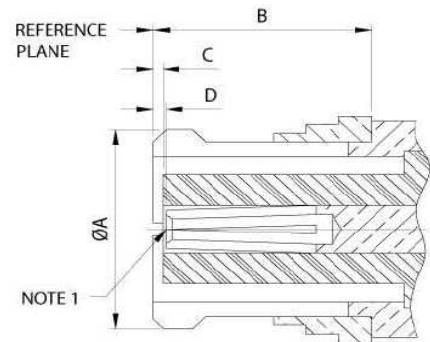
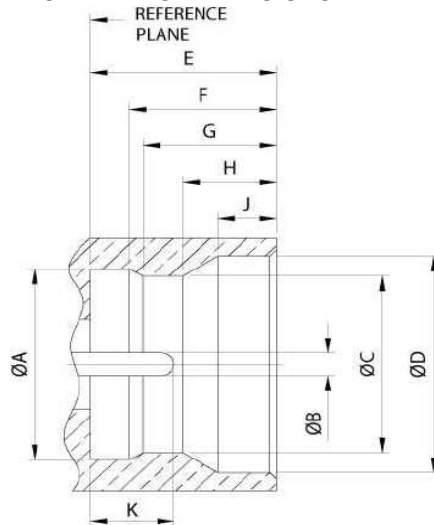

Letter	Plug					
	mm		mm		mm	
	Smooth Bore		Limited Detent		Full Detent	
	min.	max.	min.	max.	min.	max.
A	3.125	3.225	3.125	3.225	3.125	3.225
B	0.356	0.406	0.356	0.406	0.356	0.406
C	3.125	3.225	2.998	3.098	2.896	2.996
D	3.531	3.683	3.531	3.683	3.531	3.683
E	2.784	2.884	2.784	2.884	2.784	2.884
F	---	---	2.185	2.285	2.185	2.285
G	---	---	1.982	2.082	1.982	2.082
H	1.397	1.447	1.397	1.447	1.397	1.447
J	0.839	0.939	0.839	0.939	0.839	0.939
K	1.143	1.397	1.143	1.397	1.143	1.397

Letter	mm	
	min.	max.
A	---	3.34
B	3.35	---
C	0.00	0.20
D	0.00	---

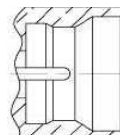
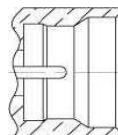
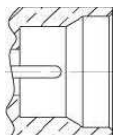

PCB Mount SMP	
Part No.:	T55B1005
Customer:	

DRW:	Dong	CHKD	Chang	MATL:	Chui	DATE	26.04.2009
APPD:	Ping			FINISH:	Hui	Sheet	1 from 4



Specifications

Electrical		
Impedance		50 Ω
Frequency	Bullet Adapter (6.45mm Length) Semi-Rigid Straight Connectors	0 - 40 GHz
	All Other In-Series Adaptors, End Launch Semi-Rigid Right Angle Connectors	0 - 12 GHz
	PCB Mount	0 - 12 GHz
Working Voltage		335 VRMS
Dielectric Withstanding Voltage		500 VRMS
VSWR	Bullet Adapter (6.45mm Length)	1.3 max. 0 - 26.5 GHz 1.5 max. 26.5 - 40 GHz
	Semi-Rigid Straight Connectors	1.2 max. 0 - 18 GHz 1.35 max. 18 - 26.5 GHz 1.7 max. 26.5 - 40 GHz
	All Other In-Series Adaptors	1.1 max. 0 - 4 GHz 1.15 max. 4 - 12 GHz 1.2 max. 12 - 18 GHz
	Semi-Rigid Right Angle Connectors	1.2 max. 0 - 18 GHz
Contact Resistance	Center Contact	6 mΩ max.
	Outer Contact	2 mΩ max.
Insulation Resistance		5 MΩ max.
Insertion loss	In-Series Adaptors	0.1 √F dB max. / 10 GHz

Material		
Parts Name	Material	Finish
Body, Metal Parts	Brass per QQ-B-626	Gold 3 micro-inches
Center Contacts	Male: Brass per QQ-B-626 Female: Berylium copper per QQ-C-530	Gold 30 micro-inches Gold 30 micro-inches
Insulators	Teflon	None
Crimp Ferrules	Annealed Brass	Gold 3 micro-inches

PCB Mount SMP	
Part No.:	T55B1005
Customer:	

DRW:	Dong	CHKD	Chang	MATL:	Chui	DATE	26.04.2009
APPD:	Ping			FINISH:	Hui	Sheet	2 from 4



Mechanical & Environmental	
Engagement Force	Full Detent: 45 N max. Limited Detent: 22 N max. Smooth Bore: 9 N max.
Disengagement Force	Full Detent: 9 N max. Limited Detent: 7 N max. Smooth Bore: 2 N max.
Contact Retention	7 N min.
Durability (Mating)	Full Detent: 100 cycles min. Limited Detent: 500 cycles min. Smooth Bore: 1000 cycles min.
Temperature Range	-65°C ~ 155°C
Vibration	MIL-STD-202 Method 204, Cond. B
Temperature Shock	MIL-STD-202 Method 107, Cond. B
Moisture Resistance	MIL-STD-202 Method 106
Mechanical Shock	MIL-STD-202 Method 213, Cond. A

Technical Drawing

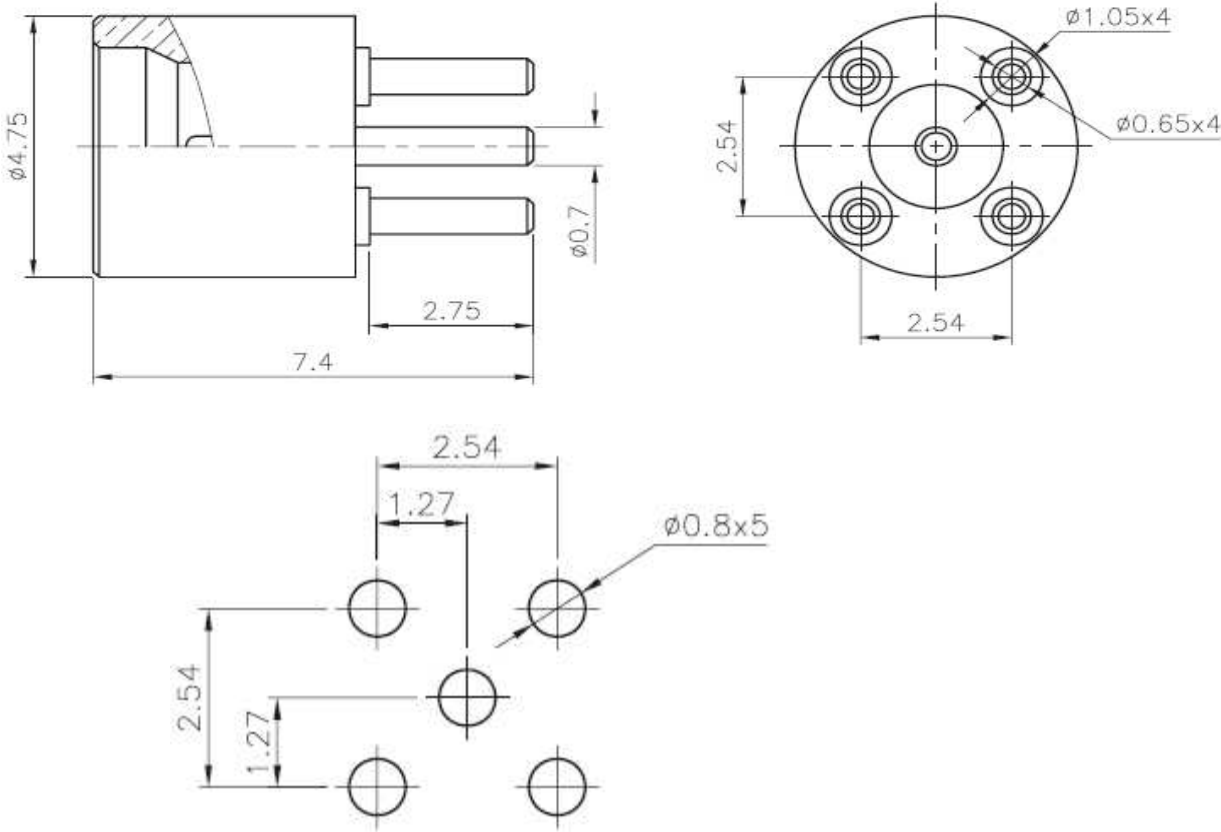

PCB Mount SMP	
Part No.:	T55B1005
Customer:	

DRW:	Dong	CHKD	Chang	MATL:	Chui	DATE	26.04.2009
APPD:	Ping			FINISH:	Hui	Sheet	3 from 4



Odering Information

Serie	-	Cable Group	Impedance	Plug	RoHS	Packing
T55B1005	-	G5	50	A1	R	BU
EDCON-Serie	-	G5 = Blunt Post	50 = 50 Ω	A1 = Smooth Bore A2 = Limited Detent A3 = Full Detent	N = no RoHS conform R = RoHS conform	BU = Bulk Ware IV = Individual Packing

PCB Mount SMP	
Part No.:	T55B1005
Customer:	

DRW:	Dong	CHKD	Chang	MATL:	Chui	DATE	26.04.2009
APPD:	Ping			FINISH:	Hui	Sheet	4 from 4