



General

As the operating frequencies go higher and higher for wireless systems, the demands for connectors with higher frequency limit and quality are increasing. SMA connectors are not designed as precision connectors, not for heavy use, and only for frequencies up to 24 GHz at most. They are widely used in microwave industry mainly because economic considerations, therefore, will be inevitably replaced for any serious applications.

Generally, to avoid the spurious propagation modes in a coaxial connector, its dimensions must be reduced accordingly as the operation frequencies go higher. Also, since a precision connector can not be made with a dielectric other than air, a well-design support bead must be used if necessary. Finally, the effects of the discontinuities in a connector are more pronounced at higher frequencies and need be well compensated during the design. All these demand highly controlled manufacture and assembly. 2.92 mm connectors are designed with thicker outer conductors while maintaining the same size of inner conductors of SMA. This makes them spurious-mode free up to 46 GHz, more reliable for heavy use, and still compatible with SMA. Edcon 2.92 mm series connectors are design and manufactured by highest standards. These include jacks and plugs in various interfaces like direct solder, panel receptacles, and adapters.

We are proud to provide these high-quality connectors with reasonable price and guaranteed fast delivery.

INTERFACE MATING DIMENSIONS

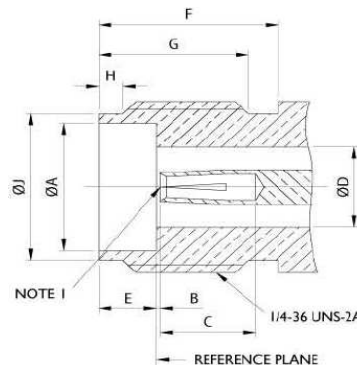
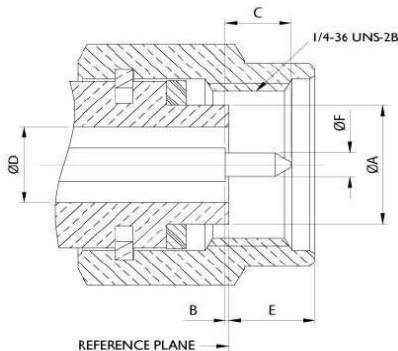

Plug		
Letter	mm	
	min.	max.
A	4.53	4.57
B	0.00	0.13
C	1.55	1.65
D	2.89	2.95
E	---	3.28
F	0.91	0.94

Plug		
Letter	mm	
	min.	max.
A	4.61	4.64
B	0.00	0.13
C	2.80	---
D	2.89	2.95
E	1.88	1.98
F	5.90	---
G	4.40	---
H	0.70	0.90
J	5.30	5.40

Note: I.D. to meet VSWR and contact resistance when mated with 0.9 / 0.94mm Dia. Pin.

Panel Mount K (2.92mm) Serie	
Part No.:	T55A1006
Customer:	

DRW:	Dong	CHKD	Chang	MATL:	Chui	DATE	26.04.2010
APPD:	Ping			FINISH	Hui	Sheet	1 from 3



Specifications

<i>Electrical</i>		
Impedance		50 Ω
Frequency Range		0 - 40 GHz
Working Voltage		250 VRMS max.
Dielectric Withstanding Voltage		750 VRMS max.
VSWR	Straight	1.3 max.
	Right Angle	1.5 max.
Contact Resistance	Center Contact	3 mΩ max.
	Outer Contact	2 mΩ max.
Insulator Resistance		5000 MΩ min.

<i>Material</i>		
Parts Name	Material	Finish
Body, Metal Parts	Stainless Steel	Passivated
Center Contacts	Plug : Brass per QQ-626 Jack: Beryllium copper per QQ-C-530	Gold 30 micro-inches Gold 30 micro-inches
Insulators	Rexolite	None
Crimp Ferrules	Annealed Brass	Gold 3 micro-inches
Clamp Gaskets	Silicone rubber	None

<i>Mechanical & Environmental</i>	
Engagement Force	2 in-lbs. max.
Disengagement Force	2 in-lbs. max.
Coupling Nut Retention	60 lbs. min.
Coupling Proof Torque	15 in-lbs. min.
Contact Retention	6 lbs. min.
Durability (Mating)	500 cycles
Temperature Range	-65°C ~ 165°C
Vibration	MIL-STD-202 Method 204 Test Cond. B
Salt Spray	MIL-STD-202 Method 101 Test Cond. B
Thermal Shock	MIL-STD-202 Method 107 Test Cond. B

**Panel Mount
K (2.92mm) Serie**

Part No.: **T55A1006**

Customer:

DRW:	Dong	CHKD	Chang	MATL:	Chui	DATE	26.04.2010
APPD:	Ping			FINISH	Hui	Sheet	2 from 3



Technical Drawing

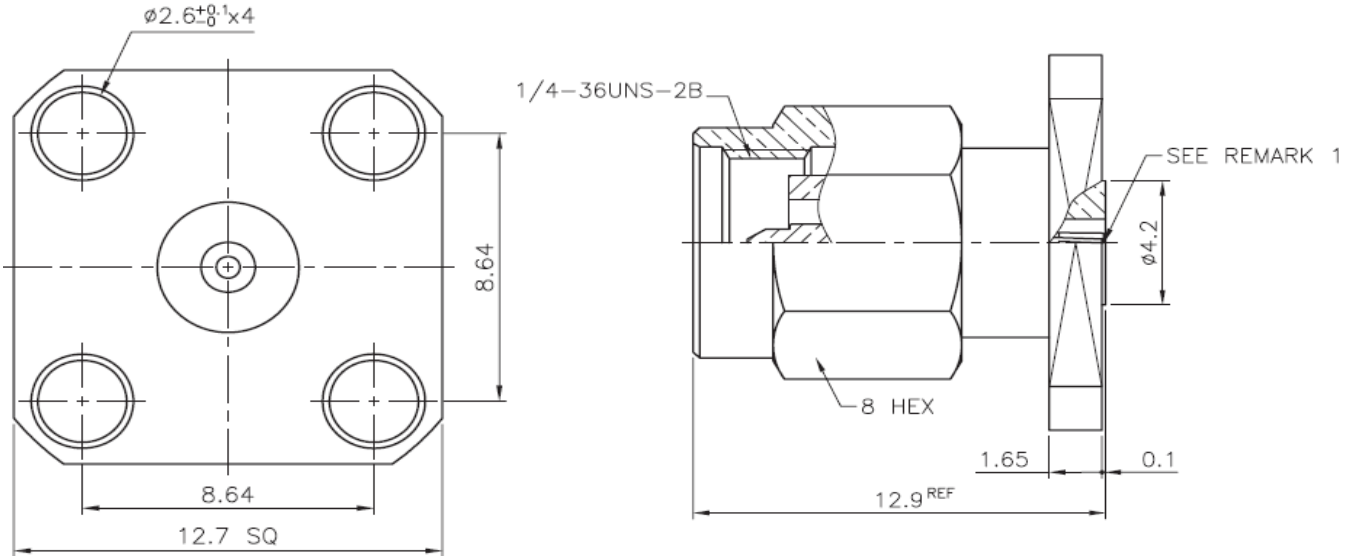

Odering Information

Serie	-	Cable Group	Impedance	No Function	RoHS	Packing
T55A1006	-	G3	50	XX	R	BU
EDCON-Serie	-	G3 = Accepts Pins	50 = 50 Ω	XX	N = no RoHS conform R = RoHS conform	BU = Bulk Ware IV = Individual Packing

Panel Mount K (2.92mm) Serie	
Part No.:	T55A1006
Customer:	

DRW:	Dong	CHKD	Chang	MATL:	Chui	DATE	26.04.2010
APPD:	Ping			FINISH	Hui	Sheet	3 from 3