

EDCON-COMPONENTS



SPECIFICATION:

Current Rating: 50mA / 12VDC
 Insulator Resistance: 100 Megaohm min.
 Dielectric Withstanding: AC 250V
 Operating Temperature: -25°C to +70°C
 Travel: 1,5mm ± 0,3mm
 Insulator Material: PA66
 Cover: PA66
 Contact Plating: Stainless Steel Silver plated
 Terminal: Brass Silver plated
 Sealed Character: IP67

P.C.B Layout

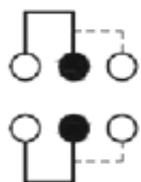
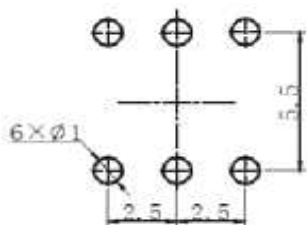

Drawing

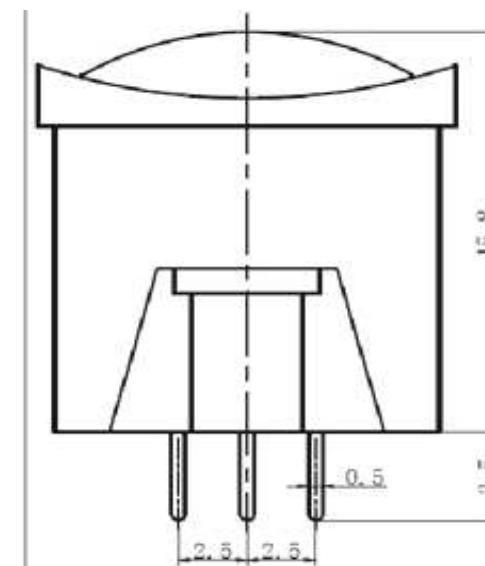
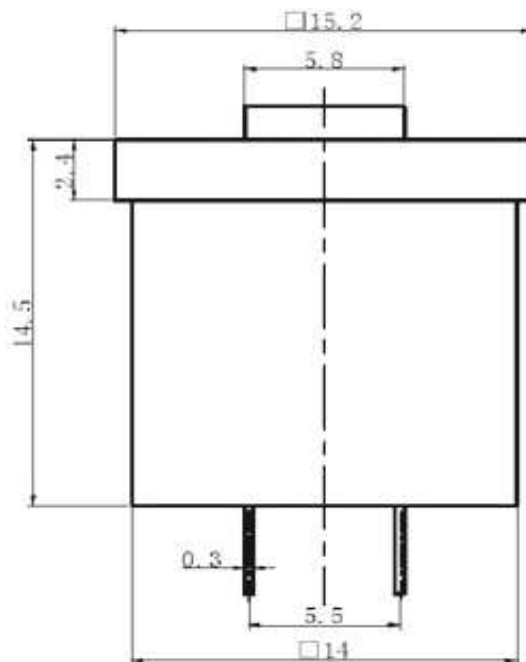

PUSH SWITCH THT LOCK / UNLOCK

Part No.: **Q11129**

Customer:

DRW:	Jason	CHKD	Wilson	MATL:	Wilson	TOLERANCE	Mason	DATE	27.07.2014
APPD:	Schumi			FINISH	Jamy		Sheet No.	1 from 3	

EDCON-COMPONENTS



Ordering Informations

Serie	Knob Color	Body Color	Operating Force	Special function	Electrical life	Fill with 0	ROHS	Packing		
Q11129	RD	GR	101	X	104	X	R	BU		

RD= Red	LG= Light Gray	101= 100gr	X= no function	104= 100000 cycles	X= no function	N= non ROHS	BU= Bulk Ware
BL= Blue	BK= Black	301= 300gr				R= ROHS conform	
GN= Green							

PUSH SWITCH THT LOCK / UNLOCK

Part No.: **Q11129**

Customer:

DRW:	Jason	CHKD	Wilson	MATL:	Wilson	TOLERANCE	Mason	DATE	27.07.2014
APPD:	Schumi			FINISH	Jamy		Sheet No.	2 from 3	

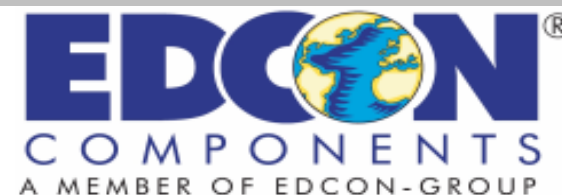

Soldering Profile for Lead Soldering

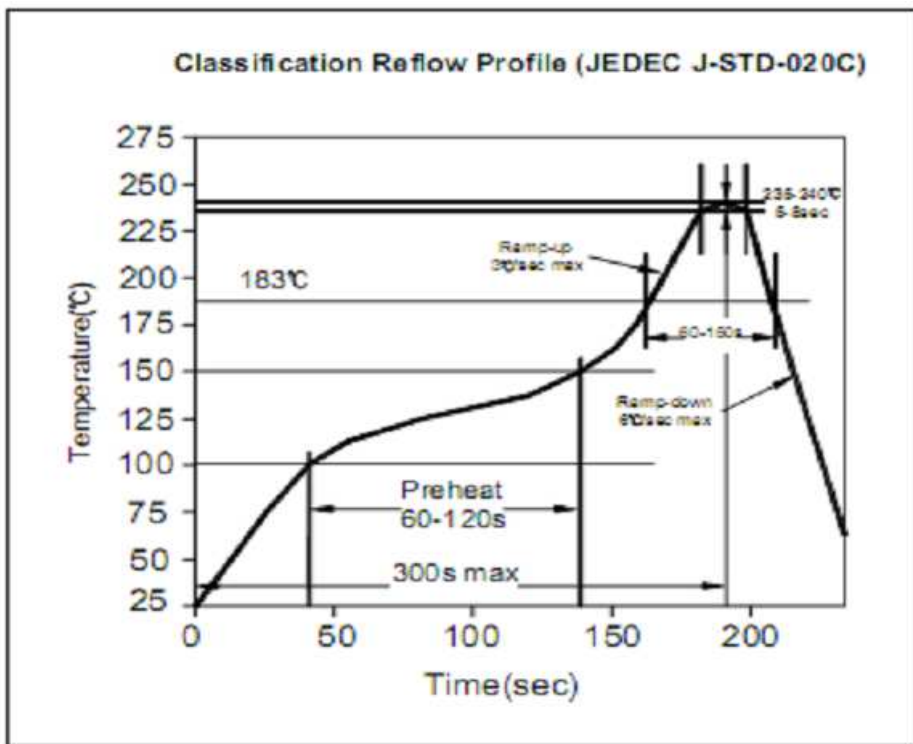

Soldering Profile for Lead Free Soldering

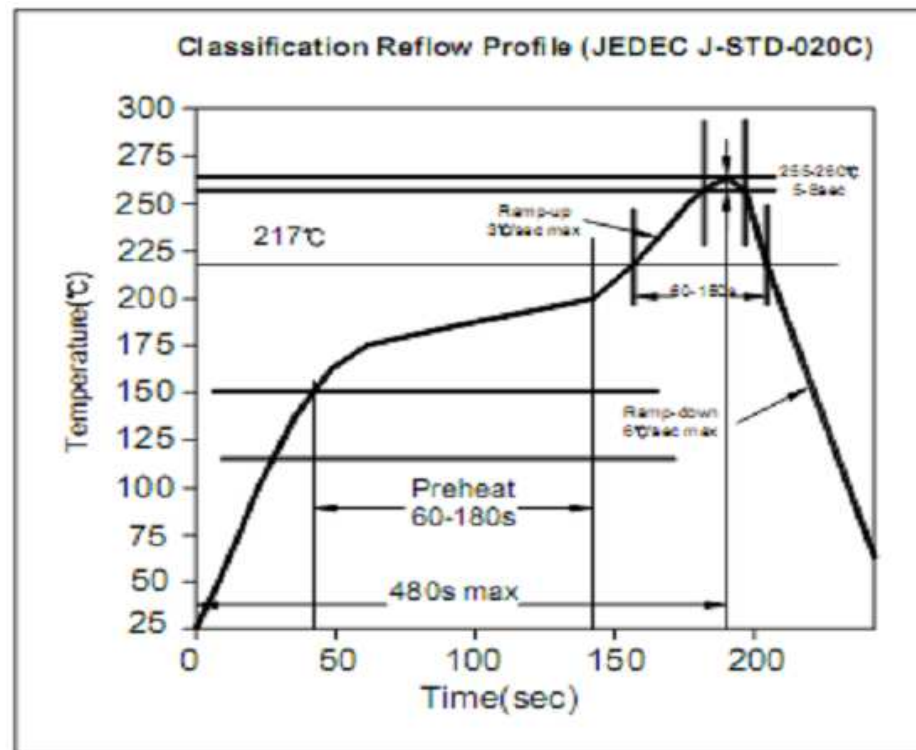

PUSH SWITCH THT LOCK / UNLOCK

Part No.: **Q11129**

DRW:	Jason	CHKD	Wilson	MATL:	Wilson	TOLERANCE	Mason	DATE	27.07.2014
APPD:	Schumi			FINISH	Jamy		Sheet No.	3 from 3	Customer: