

EDCON-COMPONENTS

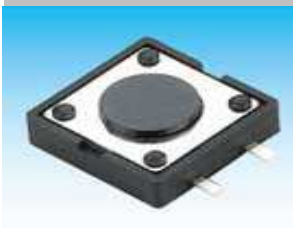

SPECIFICATION:

Current Rating: DC12V / 50mA
 Insulator Resistance: ≥ 100 Mega Ω min.
 Contact Resistance: ≤ 100 m Ω max.
 Travel: 0,25 / +/- 0,1mm
 Operating Temperature: -25°C to +70°C
 Lifetime: look order code
 Operating Force: look order code

Common Specifications

Life Test	50/80 Cycles / Min with 5VDC 5mA Resistive load Cycles of Operation: As per individual Specifications
Dry Heat Proof	80°C +/- 2°C for 96hours after Test Kept in Normal Condition for 30Min.
Moisture Resistance	60°C +/- 2°C 90~95% RH for 96 Hours After Test, Kept in Normal Condition for 30 Minutes
Cold Proof	-30°C for 96 Hours After Test Kept in Normal Condition for 30 Minutes.
Operating Force	If refers to the maximum load at the time of switching over of the contacts. (Point A in the figure)
Travel	This refers to the state of repeating the contact opening or closing momentarily at the time of the changeover of the switch to ON or OFF. Longer duration of this state

Drawing

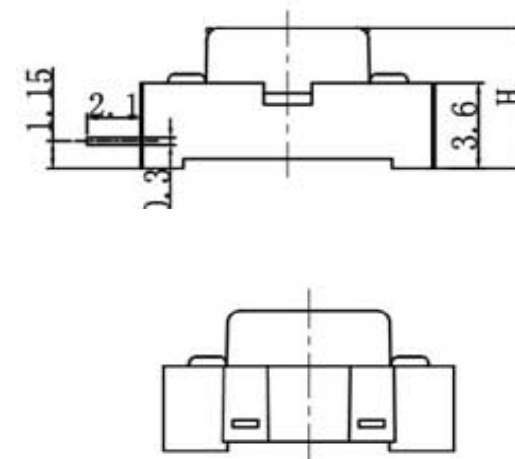
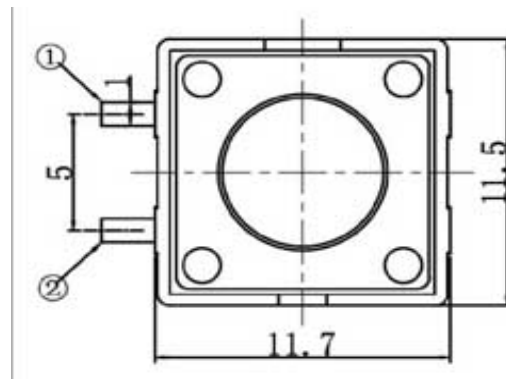

PCB Layout

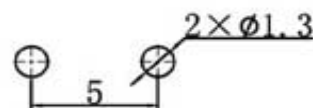

Circuit Diagram



TACT SWITCH THT
12,0x12,0mm two legs one side
 Part No.: **Q11119**

DRW:	Jason	CHKD	Wilson	MATL:	Wilson	TOLERANCE	Mason	DATE	27.07.2014
APPD:	Schumi			FINISH	Jamy		Sheet No.	1 from 4	Customer:

EDCON-COMPONENTS

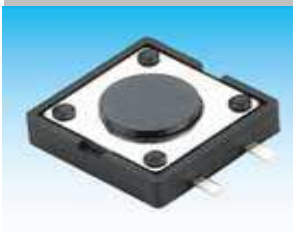

Knob Height Specifications (other specification on request)

Knob Order Code L	Height (mm)
043	4,3
045	4,5
050	5,0
055	5,5
060	6,0
065	6,5
070	7,0
075	7,5
080	8,0
085	8,5
090	9,0
095	9,5
100	10,0
105	10,5
110	11,0
115	11,5
120	12,0
125	12,5
130	13,0
150	15,0
155	15,5
170	17,0
180	18,0
210	21,0

Knob Order Code L	Height (mm)

Knob Order Code L	Height (mm)

TACT SWITCH THT	
12,0x12,0mm two legs one side	
Part No.:	Q11119
Customer:	

DRW:	Jason	CHKD	Wilson	MATL:	Wilson	TOLERANCE	Mason	DATE	27.07.2014
APPD:	Schumi			FINISH	Jamy		Sheet No.		2 from 4

EDCON-COMPONENTS

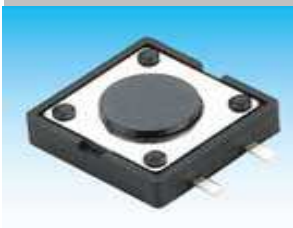

Ordering Informations

Serie	Total length (L)	Function	Operating Force	Function	Electrical life	Function	ROHS	Packing		
Q11119	043	N	181	N	803	N	R	BU		
xxx= Please look Knob Order Code		N= No function	181 = 180gr	N= No function	803= 80000 cycles by 100gr. O-Force	N= No function	N= non ROHS	BU= Bulk Ware		
					803= 80000 cycles by 130gr. O-Force		R= ROHS conform			
			281= 280gr		803= 80000 cycles by 160gr. O-Force					
					503= 50000 cycles by 250gr. O-Force					
					503= 50000 cycles by 350gr. O-Force					
					303= 30000 cycles by 500gr. O-Force					

TACT SWITCH THT	
12,0x12,0mm two legs one side	
Part No.:	Q11119
Customer:	

DRW:	Jason	CHKD	Wilson	MATL:	Wilson	TOLERANCE	Mason	DATE	27.07.2014
APPD:	Schumi			FINISH	Jamy		Sheet No.		3 from 4

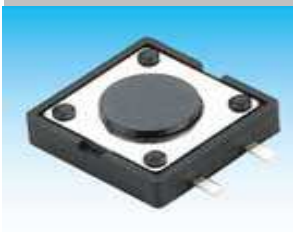

Soldering Profile for Lead Free Soldering

Classification Reflow Profile (JEDEC J-STD-020C)

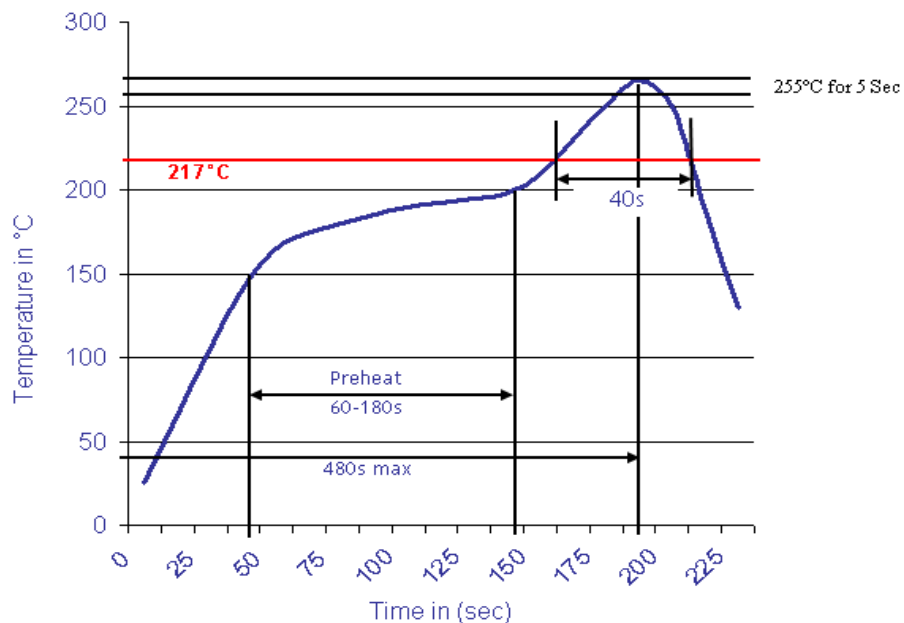

TACT SWITCH THT	
12,0x12,0mm two legs one side	
Part No.:	Q11119
Customer:	

DRW:	Jason	CHKD	Wilson	MATL:	Wilson	TOLERANCE	Mason	DATE	27.07.2014
APPD:	Schumi			FINISH	Jamy		Sheet No.	4 from 4	