

EDCON-COMPONENTS



SPECIFICATION:

Current Rating: 50mA / 12VDC
 Insulator Resistance: 100 Megaohm min.
 Dielectric Withstanding: AC 250V
 Operating Temperature: -25°C to +70°C
 Travel: 0,25mm ± 0,1mm
 Insulator Material: PA66
 Cover: PA66
 Contact Plating: Stainless Steel Silver plated
 Terminal: Brass Silver plated
 Sealed Character: IP67

P.C.B Layout

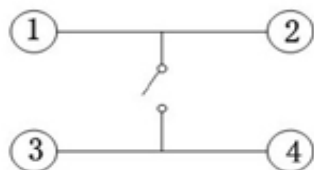
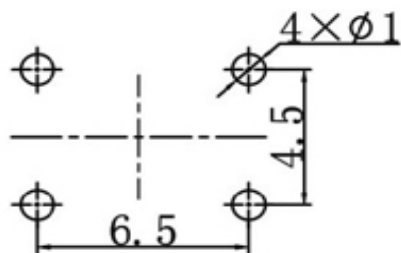

Drawing

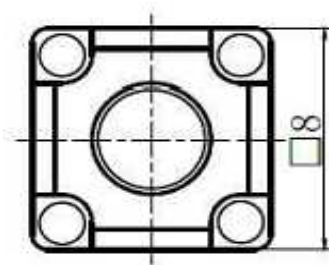
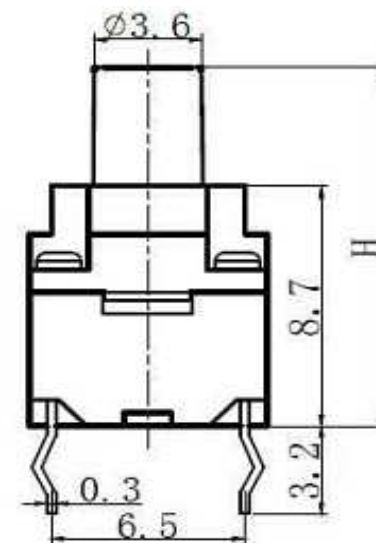
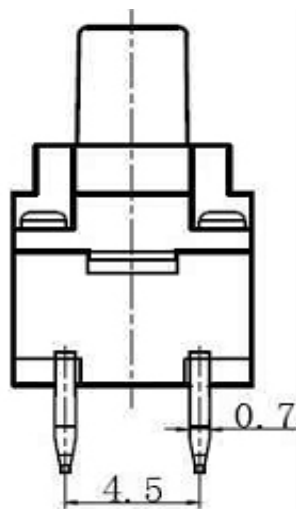

**Waterproof TACT SWITCH
THT 8x8mm**

Part No.: **Q11103**

Customer:

DRW:	Jason	CHKD	Wilson	MATL:	Wilson	TOLERANCE	Mason	DATE	27.07.2014
APPD:	Schumi			FINISH	Jamy		Sheet No.	1 from 4	

EDCON-COMPONENTS



Ordering Informations

Serie	Total height w. Body	Fill with 0	Operating Force	Polarisation Peg	Electrical life	Fill with 0	ROHS	Packing		
Q11103	125	X	231	N	104	X	R	BU		

xxx= Look Knob Order Code L	X= no function	231= 230gr	N= without Peg	104= 100000 cycles	X= no function	N= non ROHS	BU= Bulk Ware
		331= 330gr				R= ROHS conform	

Waterproof TACT SWITCH	
THT 8x8mm	
Part No.:	Q11103
Customer:	

DRW:	Jason	CHKD	Wilson	MATL:	Wilson	TOLERANCE	Mason	DATE	27.07.2014
APPD:	Schumi			FINISH	Jamy		Sheet No.		3 from 4



Soldering Profile for Lead Soldering

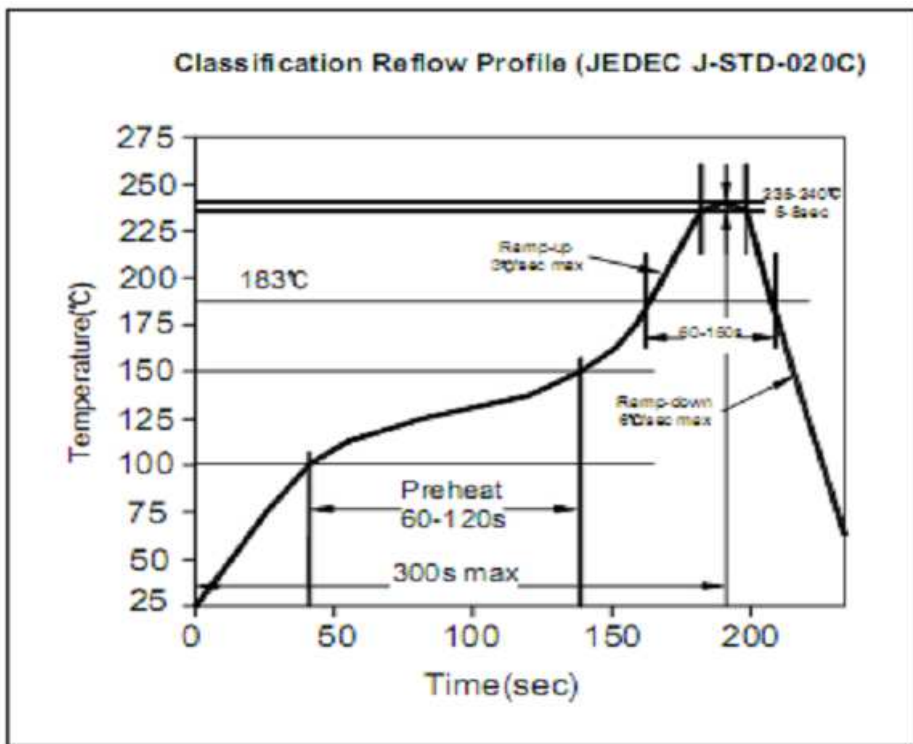

Soldering Profile for Lead Free Soldering

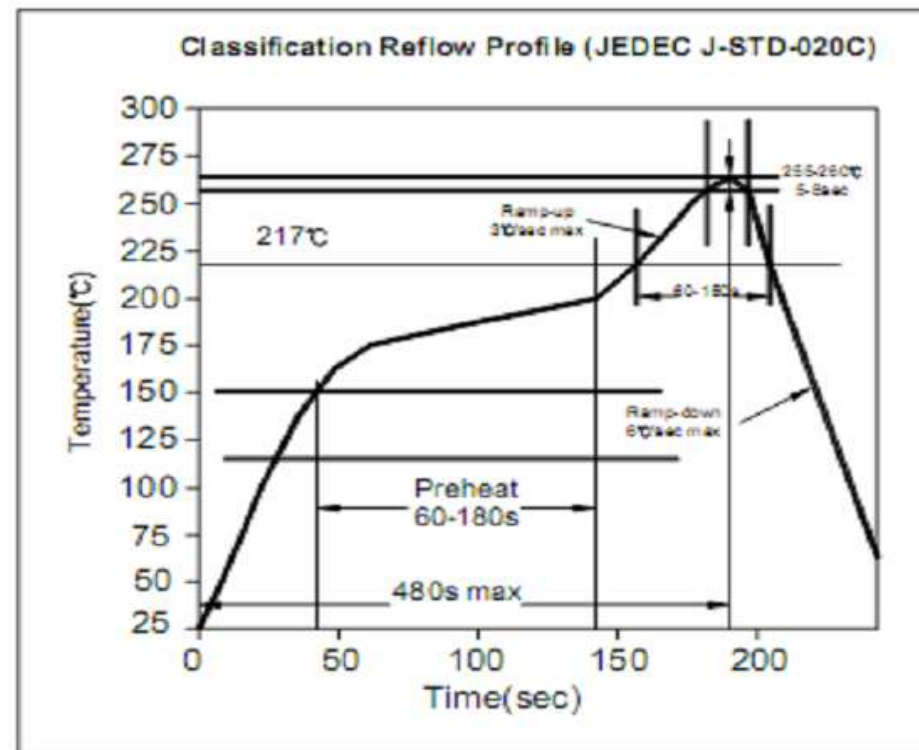

Waterproof TACT SWITCH	
THT 8x8mm	
Part No.:	Q11103
Customer:	

DRW:	Jason	CHKD	Wilson	MATL:	Wilson	TOLERANCE	Mason	DATE	27.07.2014
APPD:	Schumi			FINISH	Jamy		Sheet No.		4 from 4