

# EDCON-COMPONENTS



## SPECIFICATION:

Current Rating:	50mA / 12VDC
Insulator Resistance:	100 Megaohm min.
Dielectric Withstanding:	AC 250V
Operating Temperature:	.-25°C to +70°C
Travel:	0,25mm ± 0,1mm
Insulator Material:	PA66
Cover:	PA66
Contact Plating:	Stainless Steel Silver plated
Terminal:	Brass Silver plated
Sealed Character:	IP67

## P.C.B Layout

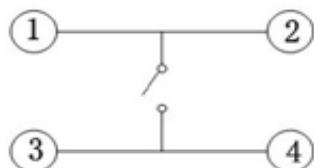
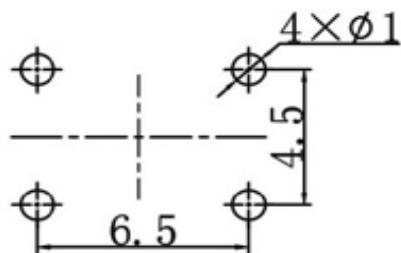

## Drawing

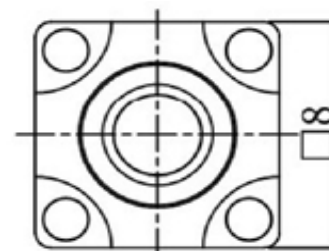
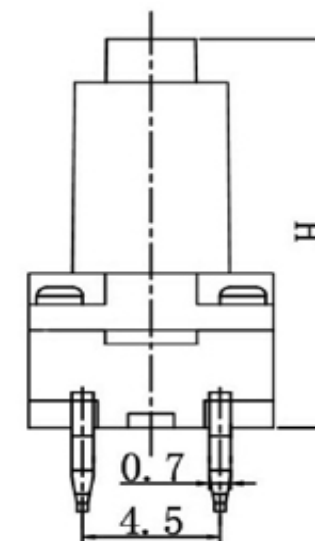
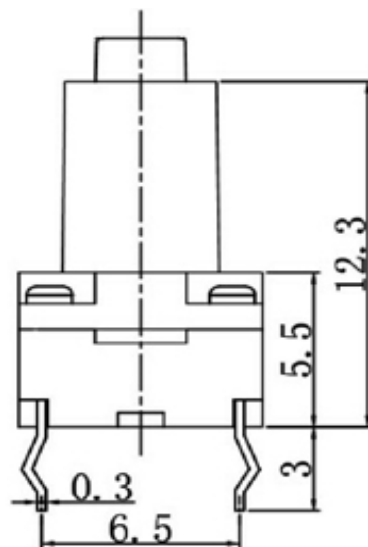

**Waterproof TACT SWITCH  
THT 8x8mm**

Part No.: **Q11102**

Customer:

DRW:	Jason	CHKD	Wilson	MATL:	Wilson	TOLERANCE	Mason	DATE	27.07.2014
APPD:	Schumi			FINISH	Jamy		Sheet No.	1 from 4	



# EDCON-COMPONENTS



## Ordering Informations

Serie	Total height w. Body	Fill with 0	Operating Force	Polarisation Peg	Electrical life	Fill with 0	ROHS	Packing		
<b>Q11102</b>	<b>150</b>	<b>X</b>	<b>231</b>	<b>N</b>	<b>104</b>	<b>X</b>	<b>R</b>	<b>BU</b>		

xxx= Look Knob Order Code L	X= no function	231= 230gr	N= without Peg	104= 100000 cycles	X= no function	N= non ROHS	BU= Bulk Ware
		331= 330gr				R= ROHS conform	

**Waterproof TACT SWITCH  
THT 8x8mm**

Part No.: **Q11102**

DRW:	Jason	CHKD	Wilson	MATL:	Wilson	TOLERANCE	Mason	DATE	27.07.2014
APPD:	Schumi			FINISH	Jamy			Sheet No.	3 from 4

Customer:



Soldering Profile for Lead Soldering

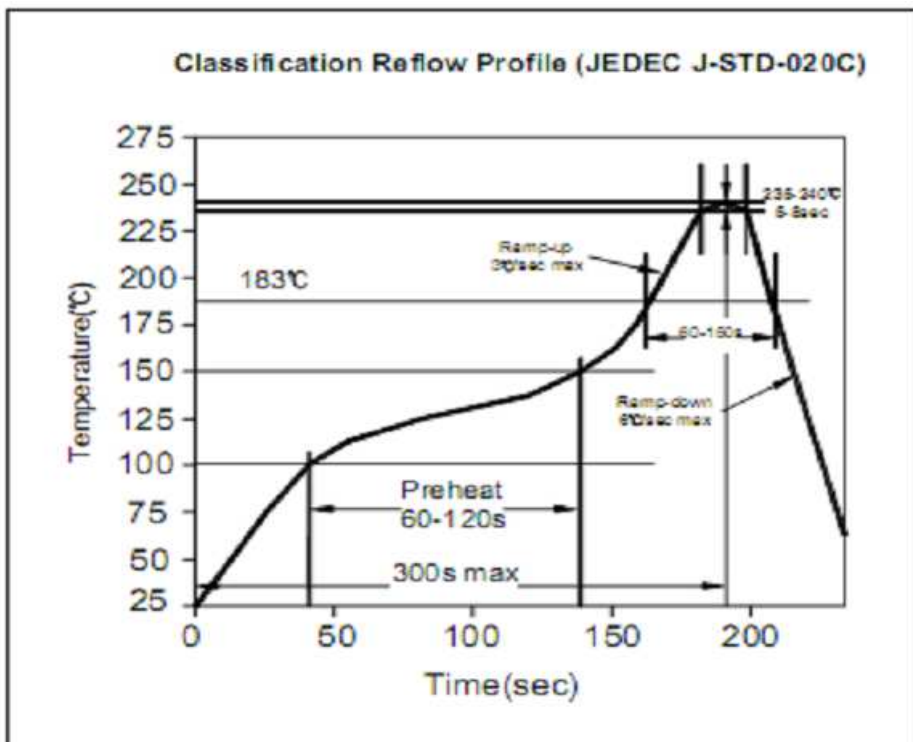

Soldering Profile for Lead Free Soldering

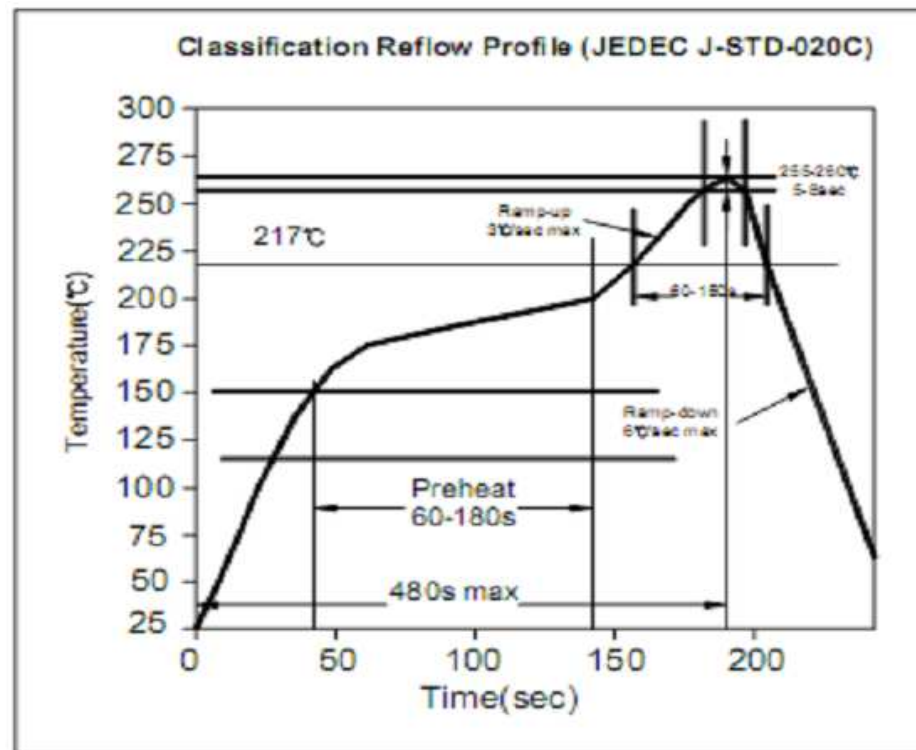

**Waterproof TACT SWITCH  
THT 8x8mm**

Part No.: **Q11102**

DRW:	Jason	CHKD	Wilson	MATL:	Wilson	TOLERANCE	Mason	DATE	27.07.2014
APPD:	Schumi			FINISH	Jamy		Sheet No.	4 from 4	Customer: