

EDCON-COMPONENTS



SPECIFICATION:

Current Rating: 50mA / 12VDC
 Insulator Resistance: 100 Megaohm min.
 Dielectric Withstanding: AC 250V
 Operating Temperature: -30°C to +85°C
 Travel: 0,25mm ± 0,1mm
 Insulator Material: PA66
 Cover: PA66
 Contact Plating: Stainless Steel Silver plated
 Terminal: Brass Silver plated

P.C.B Layout

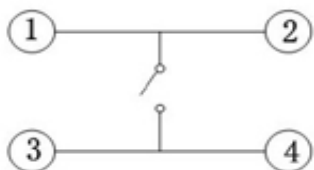
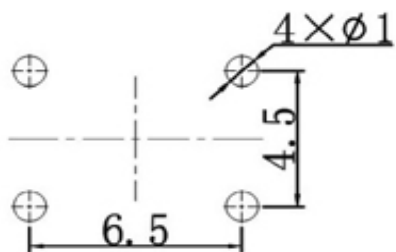

Drawing

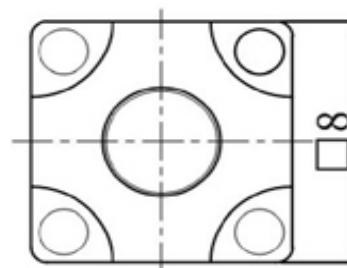
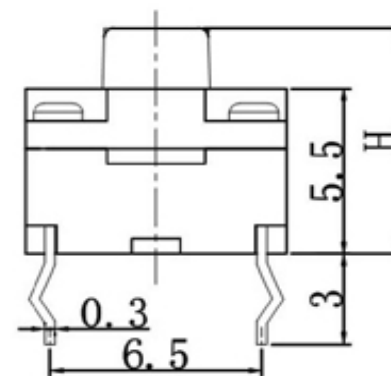
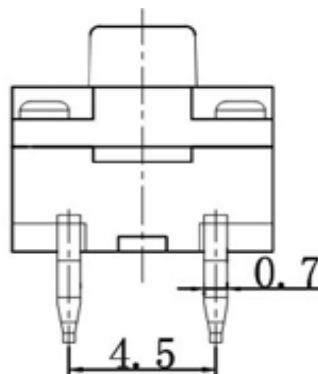

**Waterproof TACT SWITCH
THT 8x8mm**

Part No.: **Q11099**

Customer:

DRW:	Jason	CHKD	Wilson	MATL:	Wilson	TOLERANCE	Mason	DATE	27.07.2014
APPD:	Schumi			FINISH	Jamy		Sheet No.	1 from 4	

EDCON-COMPONENTS



Knob Height Specifications (other specification on request)

Knob Order Code L	Height (mm)
060	6,0
063	6,3
064	6,4
065	6,5
070	7,0
075	7,5
079	7,9
080	8,0
081	8,1
085	8,5
088	8,8
090	9,0
095	9,5
100	10,0
103	10,3
105	10,5
110	11,0
115	11,5
118	11,8
120	12,0
125	12,5
130	13,0
135	13,5
140	14,0
145	14,5
150	15,0

Knob Order Code L	Height (mm)
155	15,5
160	16,0
165	16,5
170	17,0
171	17,1
175	17,5
180	18,0
185	18,5
190	19,0
195	19,5
200	20,0
205	20,5
210	21,0
212	21,2
217	21,7
225	22,5
230	23,0
245	24,5
250	25,0
260	26,0
265	26,5
275	27,5
287	28,7
295	29,5
305	30,5

Knob Order Code L	Height (mm)

**Waterproof TACT SWITCH
THT 8x8mm**
Part No.: **Q11099**

DRW:	Jason	CHKD	Wilson	MATL:	Wilson	TOLERANCE	Mason	DATE	27.07.2014
APPD:	Schumi			FINISH	Jamy		Sheet No.		2 from 4

Customer:
email: info@edcon-components.com

EDCON-COMPONENTS



Ordering Informations

Serie	Total height w. Body	Fill with 0	Operating Force	Polarisation Peg	Electrical life	Fill with 0	ROHS	Packing		
Q11099	060	X	231	N	104	X	R	BU		

xxx= Look Knob Order Code L	X= no function	231= 230gr	N= without Peg	104= 100000 cycles	X= no function	N= non ROHS	BU= Bulk Ware
		331= 330gr				R= ROHS conform	

**Waterproof TACT SWITCH
THT 8x8mm**

Part No.: **Q11099**

DRW:	Jason	CHKD	Wilson	MATL:	Wilson	TOLERANCE	Mason	DATE	27.07.2014
APPD:	Schumi			FINISH	Jamy			Sheet No.	3 from 4

Customer:



Soldering Profile for Lead Soldering

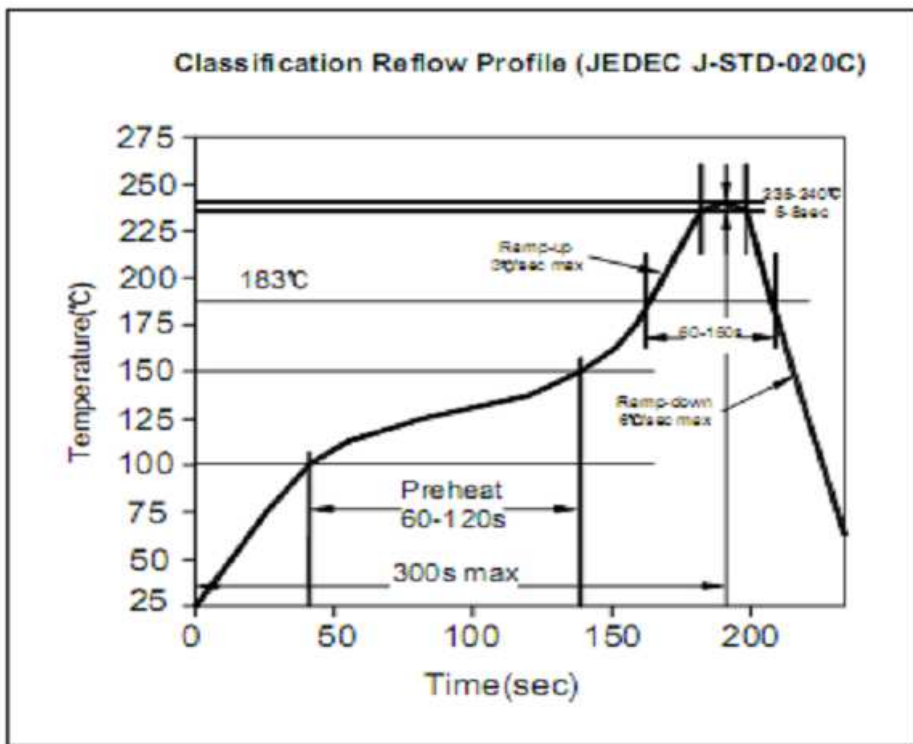

Soldering Profile for Lead Free Soldering

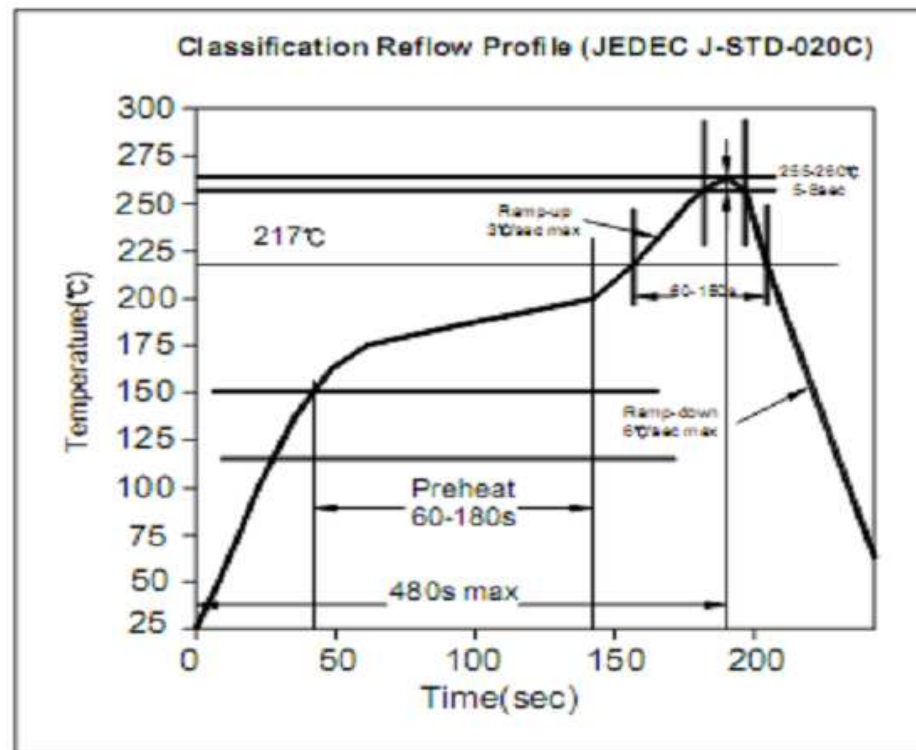

**Waterproof TACT SWITCH
THT 8x8mm**

Part No.: **Q11099**

Customer:

DRW:	Jason	CHKD	Wilson	MATL:	Wilson	TOLERANCE	Mason	DATE	27.07.2014
APPD:	Schumi			FINISH	Jamy		Sheet No.	4 from 4	