

EDCON-COMPONENTS



Description

Approval	IEC	UL
Standard:	IEC	UL
Voltage	450Volt	320Volt
Current	16A	16A
Poles	3P	3P
Body Colour	White	White
Lower-Base	PA66	PA66
Upper-Cover	PC	PC

Dimensions (mm)

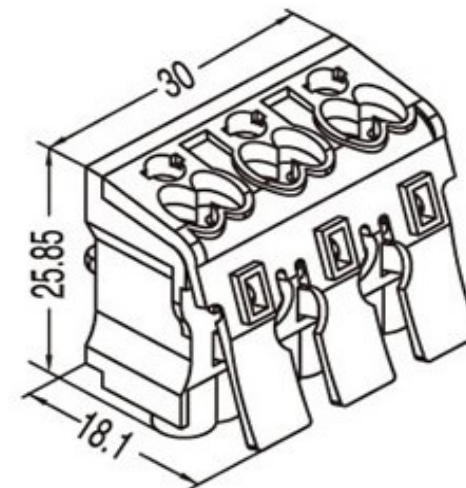

The bottom wiring hole can connect the circle earth slice **(Type A)**

The bottom wiring hole can connect the square earth slice **(Type B)**

The c wiring hole can connect the square earth slice **(Type C)**



Single-strand wire



Multi-strand wire



Fine multi-strand wire

for connecting hole a,b



Single-strand wire

Connecting hole A,B C/c

Screwless Lamp-Terminals

Part No.: **A46035**

DRW:	Jason	CHKD	Wilson	MATL:	Wilson	TOLERANCE	Mason	DATE	29.10.2023
APPD:	Schumi			FINISH	Jamy		Sheet No.		1 from 2

Customer: email: info@edcon-components.com

www.edcon-components.com

Copyright by S.Tiede

EDCON-COMPONENTS

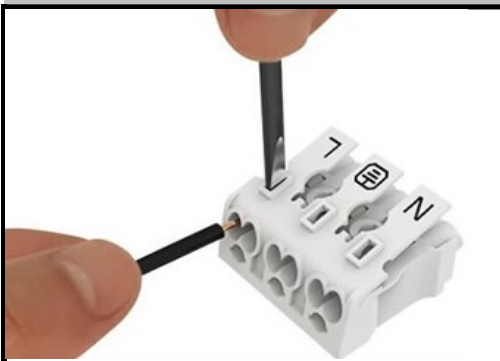

Wiring operation 1 the wire can be inserted or released by the tool through the connecting (disconnecting) hole (the single-stranded wire can be inserted directly).



Wiring operation 2: use finger or tools to press down the operation button (which is on the product) to open the connecting port, and insert or release the wire (the single-stranded wire can be inserted directly)

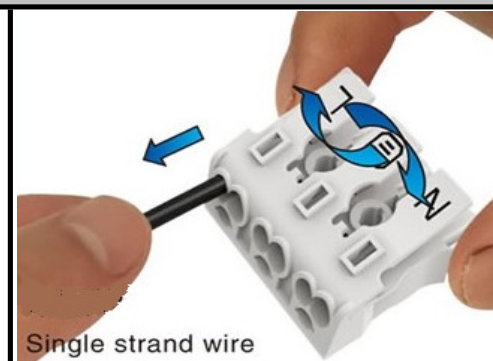

Single strand wire

Disconnection operation: if you choose the connector without button, the single-stand wire (which is inserted to A or B wiring hole) will be released by left-right rotating to connector.

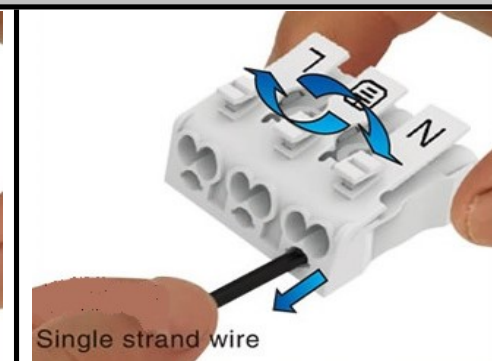

Single strand wire

Disconnection operation: the single - strang wiring (which is inserted to C or c wiring hole) will be released by left-right rotating the connector

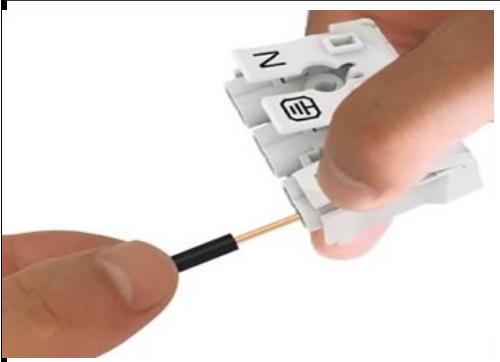

Wiring operation 2: use finger or tools to press down the operation button (which is on the product) to open the connecting port, and insert or release the wire (the single-stranded wire can be inserted directly)

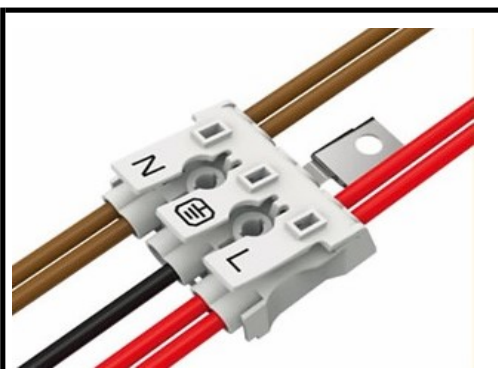

One side can connect three wire at the same time, also can connect the earth slice, it is easy to operate

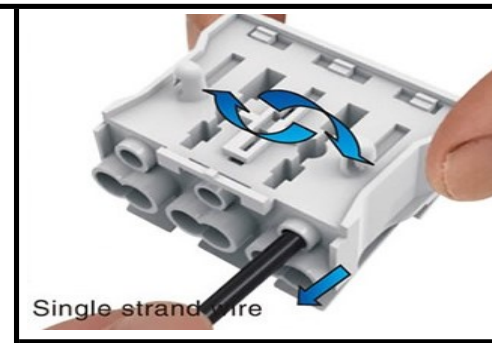

Single strand wire

Disconnecting operation: the single - strang wiring (which is inserted to C or c wiring hole) will be released by left-right rotating the connector

Screwless Lamp-Terminals

Part No.: **A46035**

DRW:	Jason	CHKD	Wilson	MATL:	Wilson	TOLERANCE	Mason	DATE	29.10.2023
APPD:	Schumi			FINISH	Jamy		Sheet No.		2 from 3

Customer:

EDCON-COMPONENTS



Ordering Informations

Serie	No od Pos.	Body Colour	Special Function	Special Function	Special Function	ROHS	Packing	
A46035	03	WH	A	0	0	R	BU	

03= 3Pos.	WH= White	A= with PCB earth ground	0= No function	0= No function	R= ROHS Conform	BU= Bulk - Ware into Polybag
		B= with Flat earth ground			N= NON ROHS Conform	
		C= with Mount earth ground				IV= Individual Packing

Screwless Lamp-Terminals

Part No.: **A46035**

Customer:

DRW:	Jason	CHKD	Wilson	MATL:	Wilson	TOLERANCE	Mason	DATE	29.10.2023
APPD:	Schumi			FINISH	Jamy		Sheet No.		2 from 2