

EDCON-COMPONENTS



Description

Approval

Standard:	IEC	UL
Voltage	450Volt	320Volt
Current	16A	16A
Body Colour	White	White
Lower-Base	PA66	PA66
Poles	1P~12P 2P,3P	1P~12P 2P,3P

(hook foot chosen 2P,3P)

Dimensions (mm)

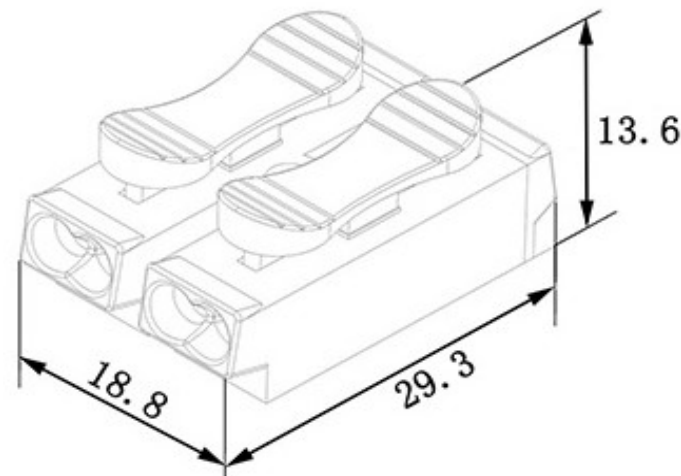

0.2-2.5mm² "s+f-st" AWG18-12

450V/4kV/2*

I_N 15A T90

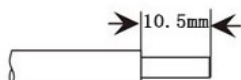

Screwless Lamp-Terminals

Part No.: **A46033**

DRW:	Jason	CHKD	Wilson	MATL:	Wilson	TOLERANCE	Mason	DATE	29.10.2023
APPD:	Schumi			FINISH	Jamy		Sheet No.		1 from 2

Customer:

www.edcon-components.com

email: info@edcon-components.com

EDCON-COMPONENTS

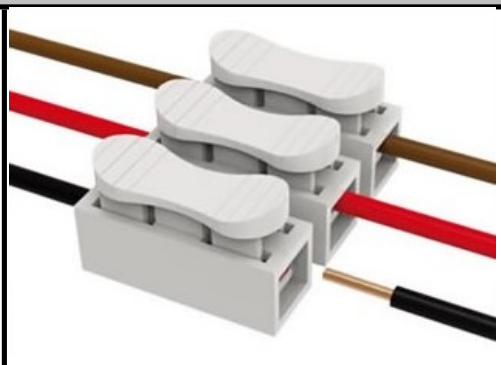
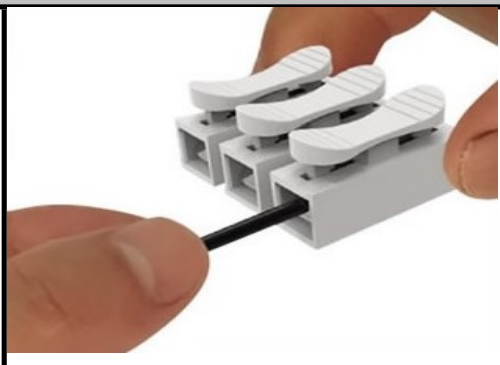
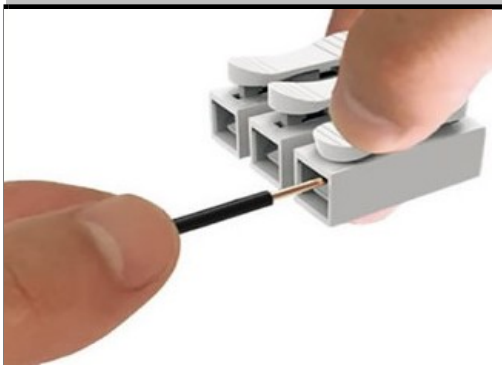
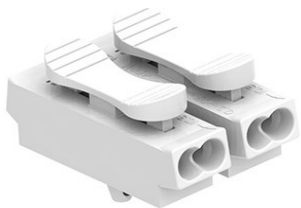

Wiring operation 1: use finger or tools to press down the operation button (which is on the product) to open the connecting port, and insert or release the wire (the single-stanged wire can be inserted directly)

Wiring operation 2: Insert the wire completely and release the operating button, and the wiring operation is done

A46033 series are applicable for kinds of wire connecting, each terminal can only connect one piece wire, and it is easy to operate.

Screwless Lamp-Terminals	
Part No.:	A46033
Customer:	

DRW:	Jason	CHKD	Wilson	MATL:	Wilson	TOLERANCE	Mason	DATE	29.10.2023
APPD:	Schumi			FINISH	Jamy		Sheet No.	2 from 3	

EDCON-COMPONENTS

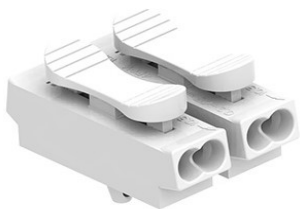

Ordering Informations

Serie	No od Pos.	Body Colour	Special Function	Special Function	Special Function	ROHS	Packing	
A46033	02	WH	0	0	0	R	BU	

02= 2Pos. Choose 1P~12P	WH= White	0= No function	0= No function	0= No function	R= ROHS Conform	BU= Bulk - Ware into Polybag
					N= NON ROHS Conform	
						IV= Individual Packing

Screwless Lamp-Terminals	
Part No.:	A46033
Customer:	

DRW:	Jason	CHKD	Wilson	MATL:	Wilson	TOLERANCE	Mason	DATE	29.10.2023
APPD:	Schumi			FINISH	Jamy		Sheet No.		2 from 2