

EDCON-COMPONENTS



The Power of LED Light



Typical Electrical & Optical Characteristics (IF=350mA and Ta=25°C)

Part-No.	Dominant Wavelength (nm) or CCT(K) X / Y corod.		Forward Voltage (V)		Luminous Flux (lm)		Current (mA)	50% Power Angle
	X	Y	Min	Max	Min	Typ	max	Typ
M11A1323	0,31	0,32	3,2	3,6	19	27	150	120

1. Tolerance of measurement of luminous flux : +/-15%
2. Tolerance of measurement of dominant Wavelength : +/-1nm
3. Tolerance of measurement of CCT (Correlated color temperature +/- 200K
4. Tolerance of measurement of forward voltage +/-0,1V

Technical Dimensions

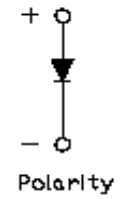
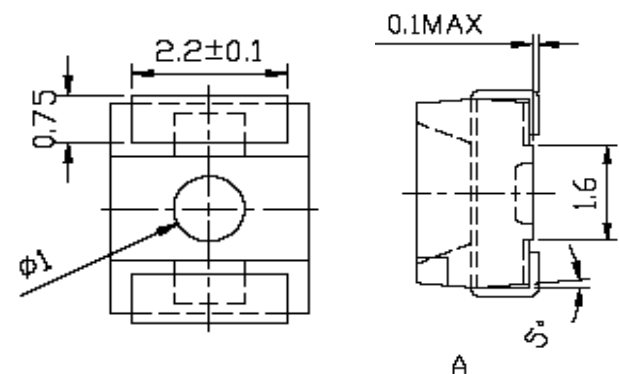
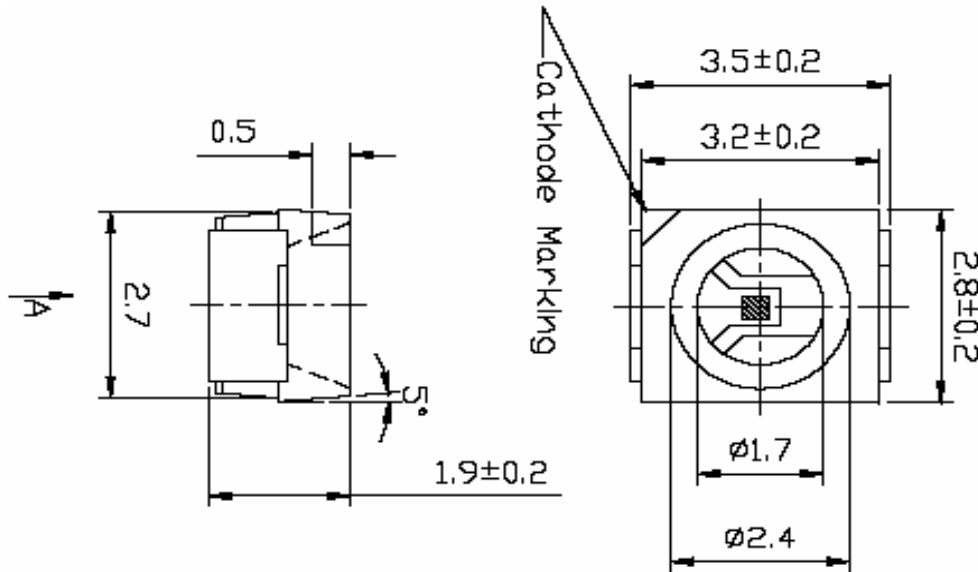

SMD DIAMOND TOP-LED

Part No.: **M11A1323**
Customer:

Features

- Contour Lights
- Garden Lighting
- Genral Lighting
- Reading Lights

Abslut Maximum Ratings (Ta=25°C)

Items	Symb ols	Abslut maximum Rating	Unit
		Red	
Power Dissipation	Pd	850	mW
Forward Current	If	350	mA
Peak Forward Current	Ifp	500	Ma
LED Junction Temperature	Tj	125	°C
Operating Temperature	Topr	.-30°C ~ +110°C	°C
Storage Temperature	Tstg	.-40°C ~ +120°C	°C

* Pulse width ≤ 0,1msec duty ≤ 1/10

DRW:	Jason	CHKD	Wilson	MATL:	Wilson	TOLERANCE	Mason	DATE	12.07.2010
APPD:	Schumi			FINISH	Jamy		Sheet No.		1 from 10

EDCON-COMPONENTS



The Power of LED Light



BIN GUIDE / HIGH POWER

Code	Luminous Flux Range		Code	Luminous Flux Range	
	min	max.		min	max.
A	1	2	P2	70	80
B	2	2,5	M1	80	90
C	2,5	3,2	M2	90	100
D	3,2	4	N1	100	110
E	4	5	N2	110	120
F	5	6,2	P1	120	130
G	6,2	7,7	P2	130	140
H	7,7	9,6	Q1	140	150
J	9,6	12	Q2	150	160
K	12	15	R1	160	170
L1	15	19	R2	170	180
L2	19	24	S1	180	200
M1	24	30	S2	200	220
M2	30	40	T1	220	240
N1	40	50	T2	240	260
N2	50	60	U1	250	280
P1	60	70			

Tolerance of measurement of luminous Flux is +/- 15%

Code	CCT Range		Code	CCT Range	
	Min	Max		Min	Max
A	2700	2900	M	4900	5100
B	2900	3100	N	5100	5500
C	3100	3300	P	5500	6000
D	3300	3500	Q	6000	6500
E	3500	3700	R	6500	7000
F	3700	3900	S	7000	7500
G	3900	4100	T	7500	8000
H	4100	4300	U	8000	9000
J	4300	4500	V	9000	10000
K	4500	4700	W	10000	12000
L	4700	4900			

Tolerance of measurement of CCT is +/-100K.

Color Code	B		H		G/E		F		Y		Q/P		R/U	
	Min	max	Min	max	Min	max	Min	max	Min	max	Min	max	Min	max
D0	450	455	490	495	515	520	560	565	580	583	600	605	620	625
D1	455	460	495	500	520	525	565	570	583	586	605	610	625	630
D2	460	465	500	505	525	530	570	575	586	589	610	615	630	635
D3	465	470	505	510	530	535	575	580	589	592	615	620	635	640
D4	470	475	510	515	535	540			592	595			640	645
D5	475	480			540	545			595	598			645	650
D6	480	485			545	550							650	655
D7	485	490			550	555							655	660
D8					555	560							660	665

Tolerance of measurement of dominant wavelength is +/-1nm

SMD DIAMOND TOP-LED

Part No.: **M11A1323**

DRW:	Jason	CHKD	Wilson	MATL:	Wilson	TOLERANCE	Mason	DATE	12.07.2010
APPD:	Schumi			FINISH	Jamy			Sheet No.	2 from 10

Customer:

EDCON-COMPONENTS



The Power of LED Light



Typical Electrical / Optical Characteristics Curves (Ta=25°C Unless otherwise noted)

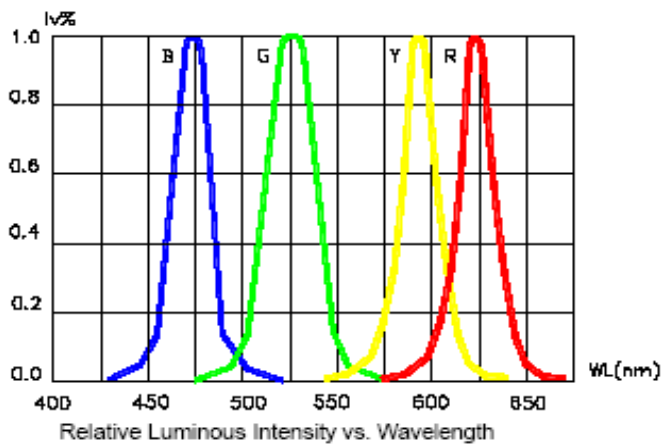
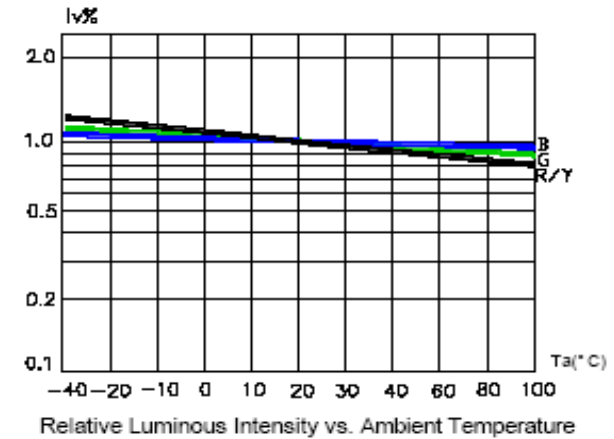
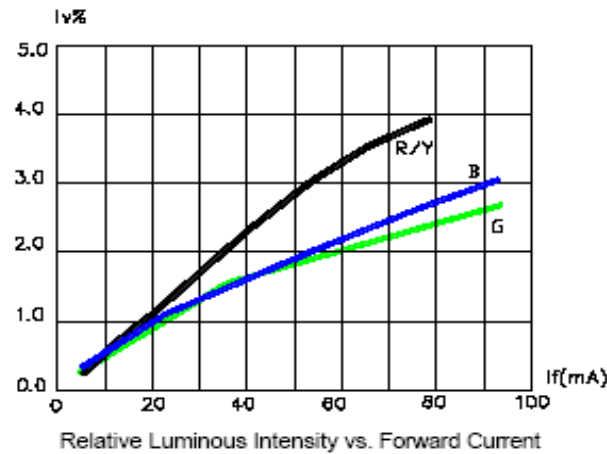
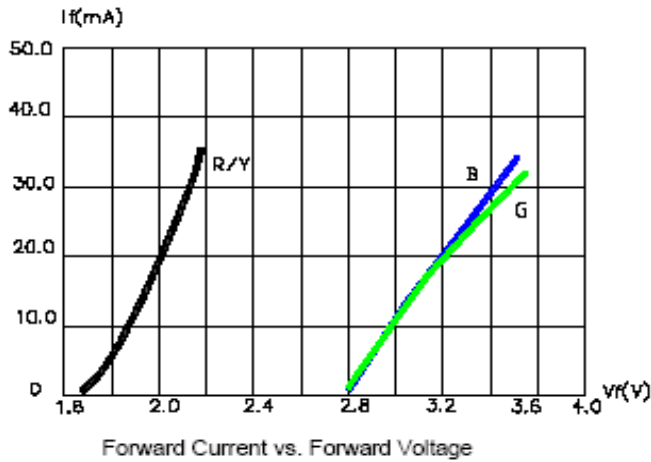

Code	Forward Voltage Rank	
	Min.	Max.
A	1,6	1,8
B	1,8	2,0
C	2,0	2,2
D	2,2	2,4
E	2,4	2,6
F	2,6	2,8
G	2,8	3,0
H	3,0	3,2

Tolerance of measurement of forward voltage is +/-0,1V

Code	Forward Voltage Rank	
	Min.	Max.
J	3,20	3,40
K	3,40	3,60
L	3,60	3,80
M	3,80	4,00
N	4,00	4,20
P	4,20	4,40
Q	4,40	4,60
R	4,60	4,80

SMD DIAMOND TOP-LED

Part No.: **M11A1323**

Customer:

DRW:	Jason	CHKD	Wilson	MATL:	Wilson	TOLERANCE	Mason	DATE	12.07.2010
APPD:	Schumi			FINISH	Jamy		Sheet No.		3 from 10

EDCON-COMPONENTS



The Power of LED Light



Typical Representative Spatial Radiation Paddern of single LED

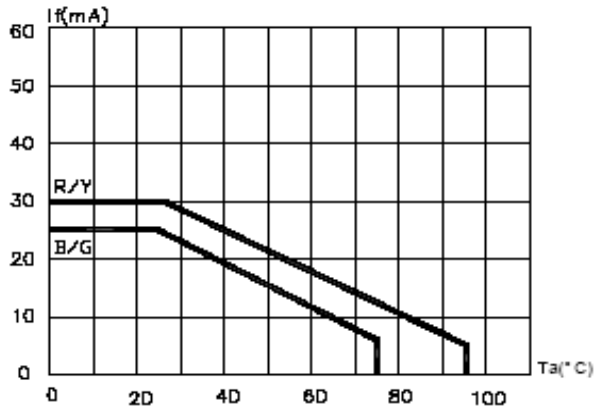

Maximum Forward Current vs Ambient Temperature

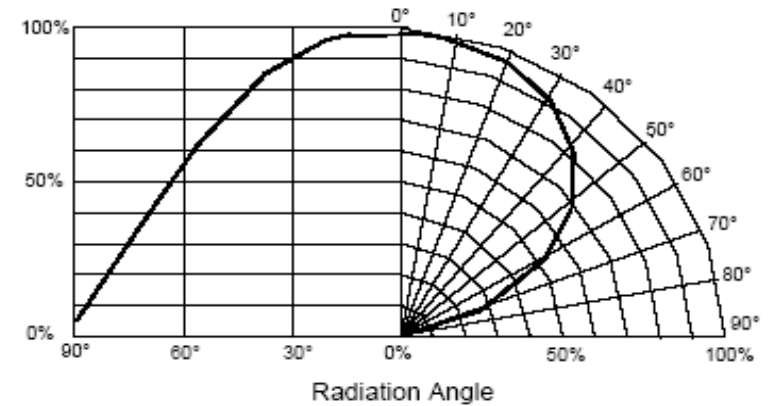

PCB PAD Layout Dimensions

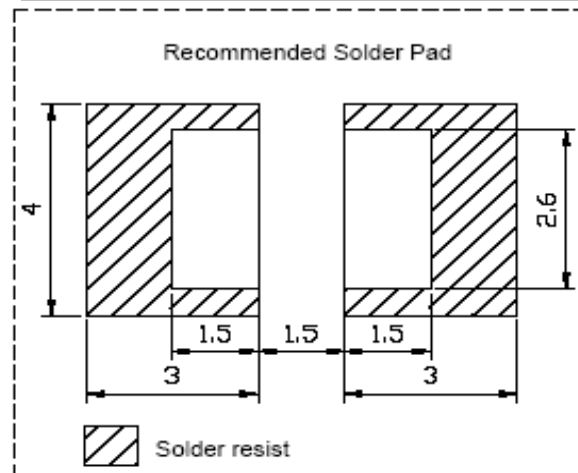

SMD DIAMOND TOP-LED

Part No.: **M11A1323**

Customer:

DRW:	Jason	CHKD	Wilson	MATL:	Wilson	TOLERANCE	Mason	DATE	12.07.2010
APPD:	Schumi			FINISH	Jamy		Sheet No.	4 from 10	

www.edcon-components.com

email: info@edcon-components.com

EDCON-COMPONENTS



The Power of LED Light



Handling Informations

- The outer diameter of the TOP LED pickup nozzle should not exceed the size of the LED to prevent air leaks. The inner diameter of the nozzle should be as large as possible.
- A pliable material is suggested for the nozzle tip to avoid scratching or damaging the LED surface during pickup.
- The dimensions of the component must be accurately programmed in the pick-and-place machine to insure precise pickup and avoid damage during production.

Compare to epoxy encapsulant that is hard and brittle, silicone is softer and flexible. Although its characteristic significantly reduces thermal stress, it is more susceptible to damage by external mechanical force. As a result, special handling precautions need to be observed during assembly using silicone encapsulated LED products. Failure to comply might lead to damage and premature failure of the LED.

- Handle the component along the side surfaces by using forceps or appropriate tools



- Do not directly touch or handle the silicone lens surface. It may damage the internal circuitry.

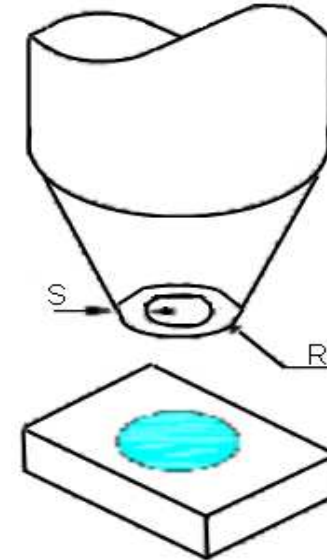

- Do not stack together assembled PCBs containing exposed LEDs. Outside impact may scratch the silicone lens or damage the internal circuitry.

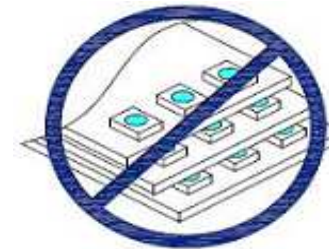

SMD DIAMOND TOP-LED

Part No.: **M11A1323**

Customer:

DRW:	Jason	CHKD	Wilson	MATL:	Wilson	TOLERANCE	Mason	DATE	12.07.2010
APPD:	Schumi			FINISH	Jamy		Sheet No.		5 from 10

EDCON-COMPONENTS



The Power of LED Light



Moisture Proof Packing

In Order to prevent moisture absorption into DIAMOND = TOP LED / XEON POWER during the transportation and storage. DIAMOND TOP-LED / XEON-POWER LED is packed in a moisture barrier bag. Desiccants and humidity indicator are packed together with DIAMOND TOP-LED / XEON-POWER LED as the secondary protection. The indication of humidity card provides the information of humidity within TOP Packing.

Storage

Shelf life in original sealed bag in storage condition of <math><40^{\circ}\text{C}</math> and 90% RH is 12 months. Baking is required whenever shelf life is expired. Before opening the packaging please check whether bag leak air or not. After opening the DIAMOND TOP-LED / XEON POWER LED must be stored under the condition <math><30^{\circ}\text{C}</math> and 60% RH. Under this condition DIAMOND TOP-LED / XEON POWER LED must be used (subject to reflow) within 24-hours after bag opening, and re-baking is required when exceeding 24 hours. For baking, place DIAMOND TOP-LED / XEON POWER LED in oven at temperature $75^{\circ}\text{C} \pm 5^{\circ}\text{C}$ and relative humidity <math><10\% \text{RH}</math>, for 24 hours. Take out the material from packaging bag for re-bake. Do not open the door of oven frequently during the baking process.

Manual soldering (We do not recommend this method strongly).

No mechanical stress should be exerted on the resin portion of DIAMOND TOP-LED / XEON POWER during soldering.

Handling of DIAMOND TOP-LED / XEON POWER LED should be done when the package has been cooled down to below 40°C or less. This is to prevent the DIAMOND TOP-LED / XEON POWER failures due to the thermal-mechanical stress during handling.

Reflow soldering should not be done more than one time.

No stress should be exerted on the package during soldering.

Electrostatic Discharge and Surge current.

Electrostatic discharge (ESD) or surge current (EOS) may damage LED.

Precautions such as ESD wrist strap, ESD shoe strap or antistatic gloves must be worn whenever handling DIAMOND TOP-LED / XEON POWER LED.

All devices, equipment and machinery must be properly grounded.

It is recommended to perform electrical test to screen out ESD failures in final inspection.

It is important to eliminate the possibility of surge current during circuitry design.

Heat Management

Heat management of DIAMOND TOP-LED / XEON POWER must be taken into consideration during the design stage of DIAMOND TOP-LED / XEON POWER LED application. The current should be de-rated appropriately by referring to the de-rating curve attached on each product specification.

SMD DIAMOND TOP-LED

Part No.: **M11A1323**

DRW:	Jason	CHKD	Wilson	MATL:	Wilson	TOLERANCE	Mason	DATE	12.07.2010	Customer:
APPD:	Schumi			FINISH	Jamy		Sheet No.	6 from 10		

www.edcon-components.com

email: info@edcon-components.com

EDCON-COMPONENTS

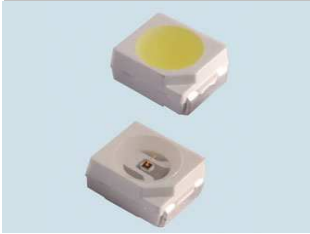

The Power of LED Light



Packing Specifications

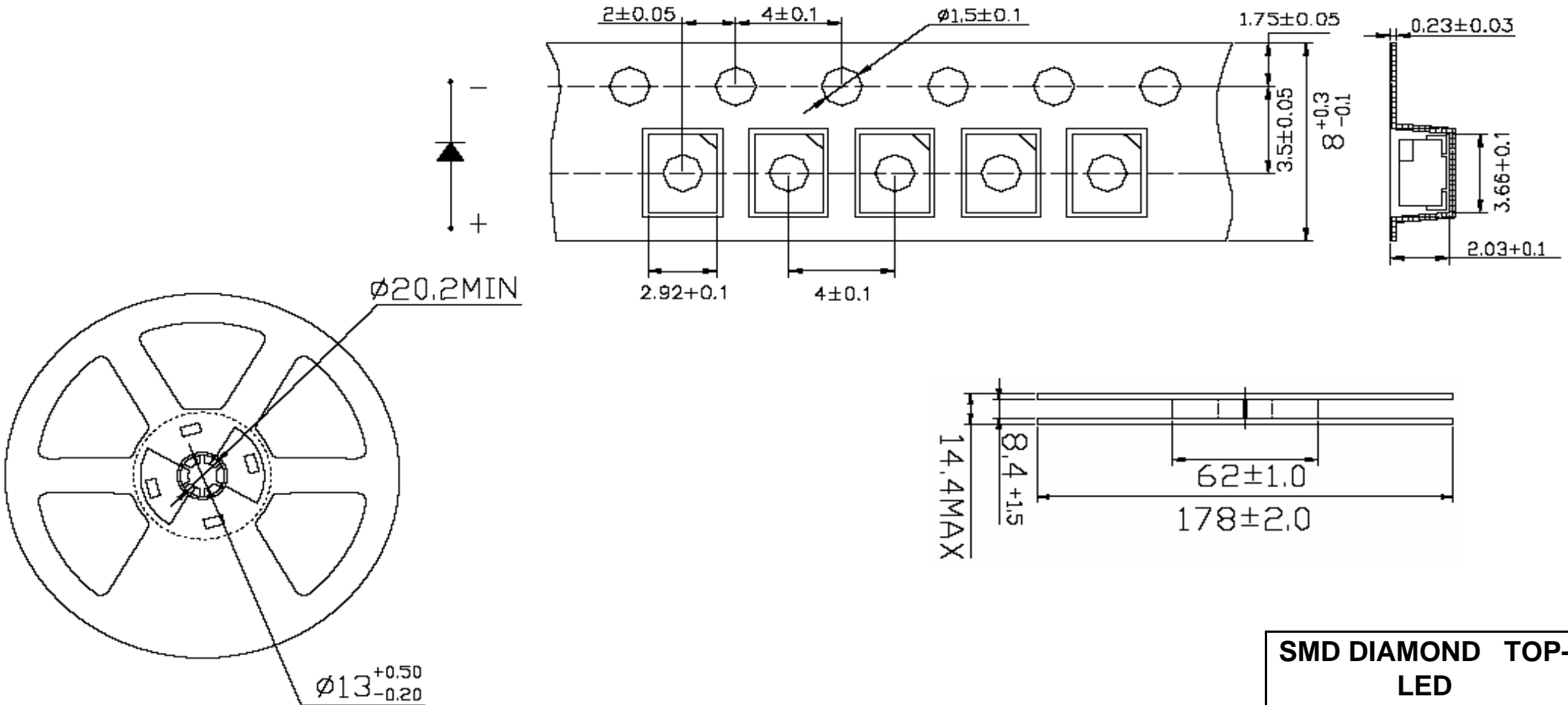

SMD DIAMOND TOP-LED

Part No.: **M11A1323**

Customer:

DRW:	Jason	CHKD	Wilson	MATL:	Wilson	TOLERANCE	Mason	DATE	12.07.2010
APPD:	Schumi			FINISH	Jamy		Sheet No.	7 from 10	

EDCON-COMPONENTS

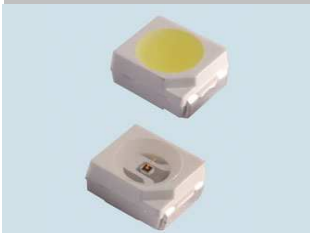

The Power of LED Light



Ordering Informations

Serie	Color Code	ROHS	Packing							
-------	------------	------	---------	--	--	--	--	--	--	--

M11A1323	WH	R	TR							
-----------------	-----------	----------	-----------	--	--	--	--	--	--	--

WH= White	R= ROHS Conform	TR= TAPE REEL
	N= NON ROHS	BU= Bulk-Ware

SMD DIAMOND TOP-LED
Part No.: M11A1323
Customer:

DRW:	Jason	CHKD	Wilson	MATL:	Wilson	TOLERANCE	Mason	DATE	12.07.2010
APPD:	Schumi			FINISH	Jamy		Sheet No.	8 from 10	

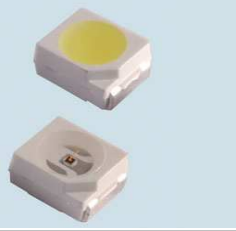

The Power of LED Light



Soldering Profile Curve

Classification Reflow Profile (JEDEC J-STD-020C)

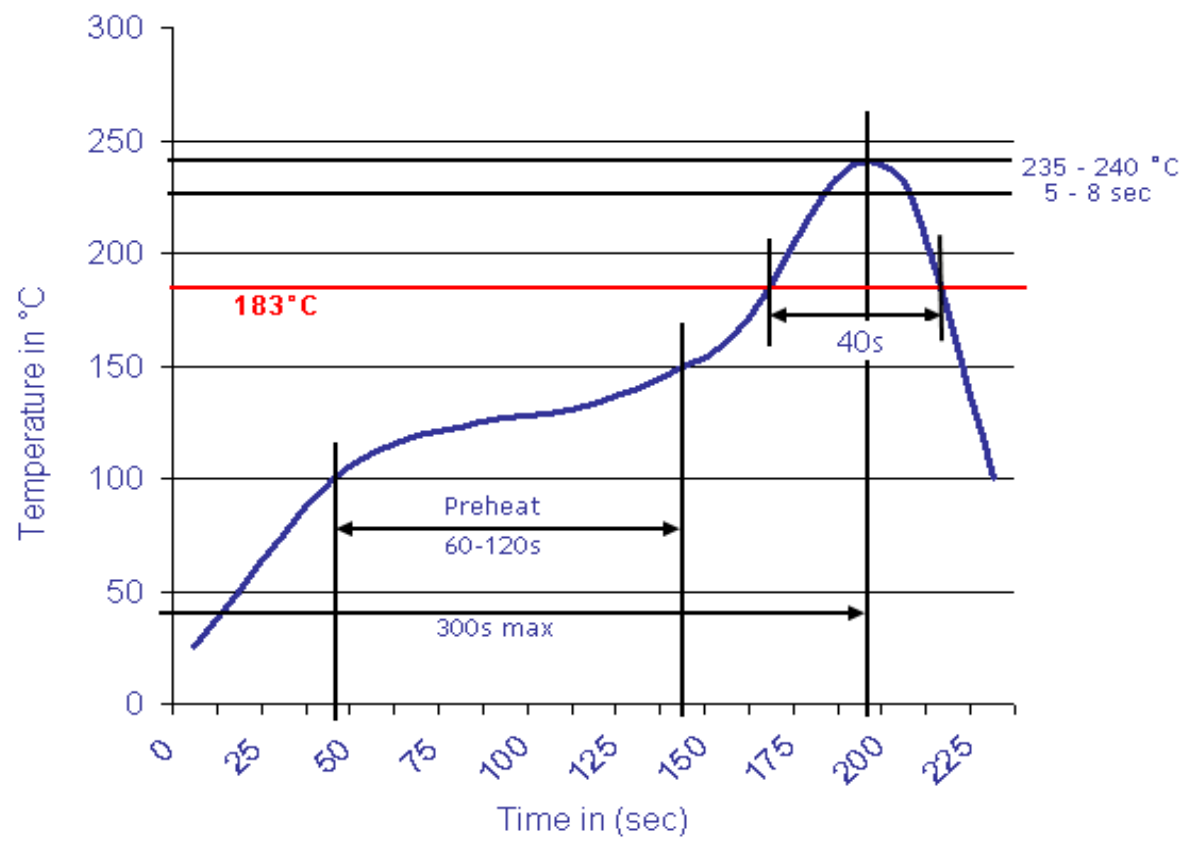

SMD DIAMOND TOP-LED

Part No.: **M11A1323**

DRW:	Jason	CHKD	Wilson	MATL:	Wilson	TOLERANCE	Mason	DATE	12.07.2010
APPD:	Schumi			FINISH	Jamy		Sheet No.	9 from 10	Customer:

EDCON-COMPONENTS

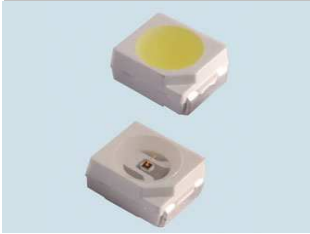

The Power of LED Light



Spectral Color Curve

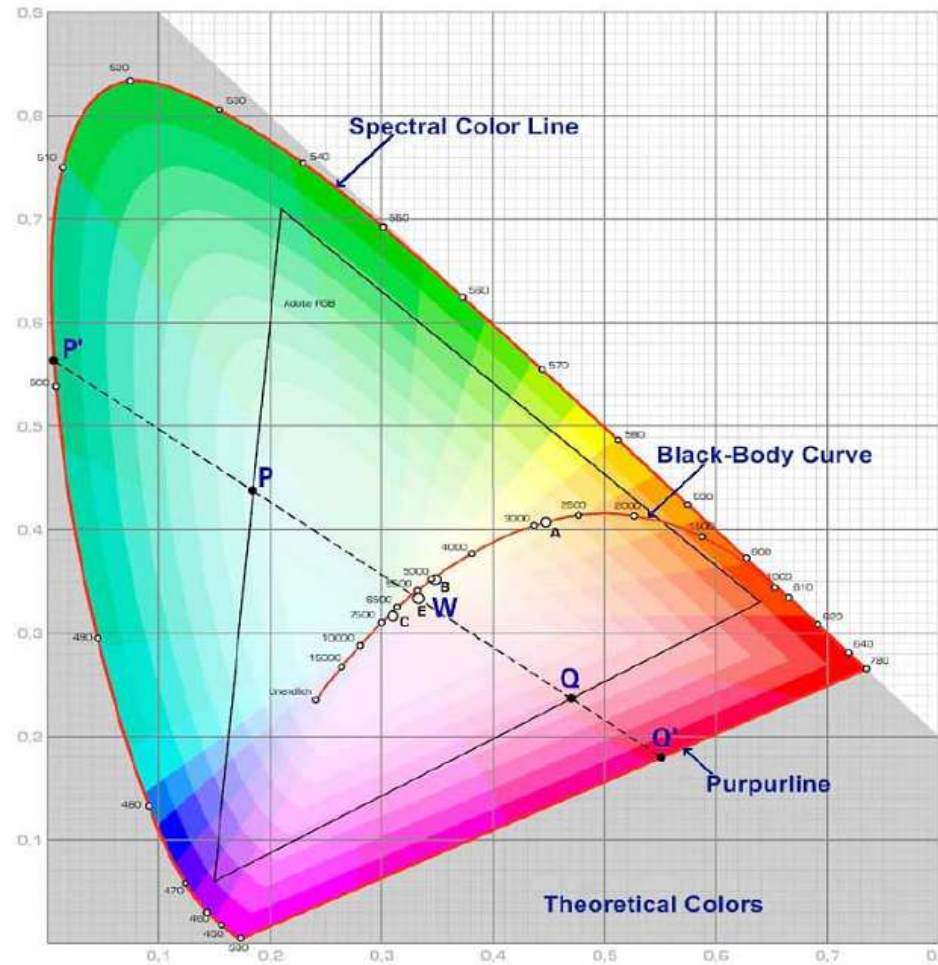

SMD DIAMOND TOP-LED

Part No.: **M11A1323**

Customer:

DRW:	Jason	CHKD	Wilson	MATL:	Wilson	TOLERANCE	Mason	DATE	12.07.2010
APPD:	Schumi			FINISH	Jamy		Sheet No.	10 from 10	

www.edcon-components.com

email: info@edcon-components.com