

**Applications**

- Interior automotive lighting
- Optical indicators
- Communication Products
- Backlighting
- Toys

**Technical Drawing**

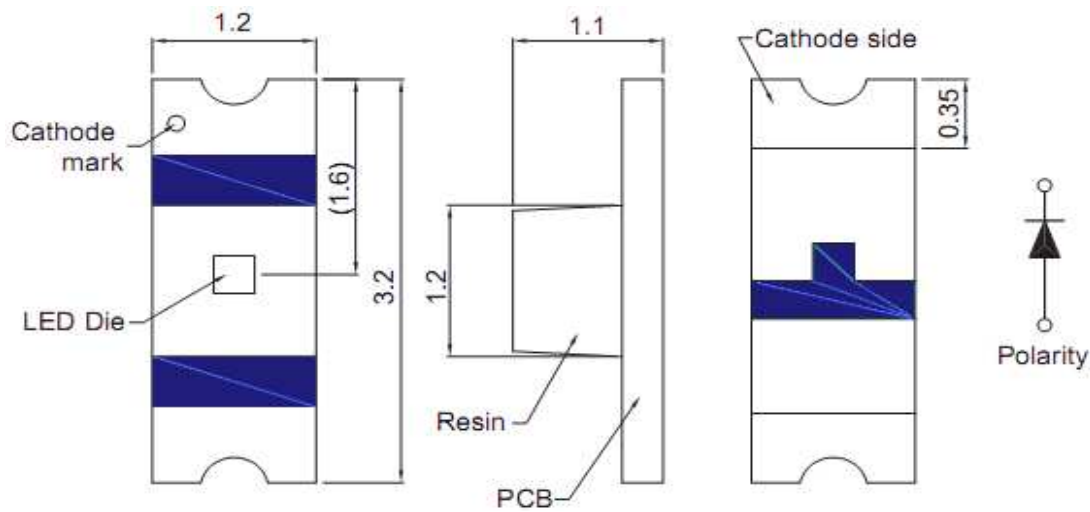

**Recommended Soldering Pattern**

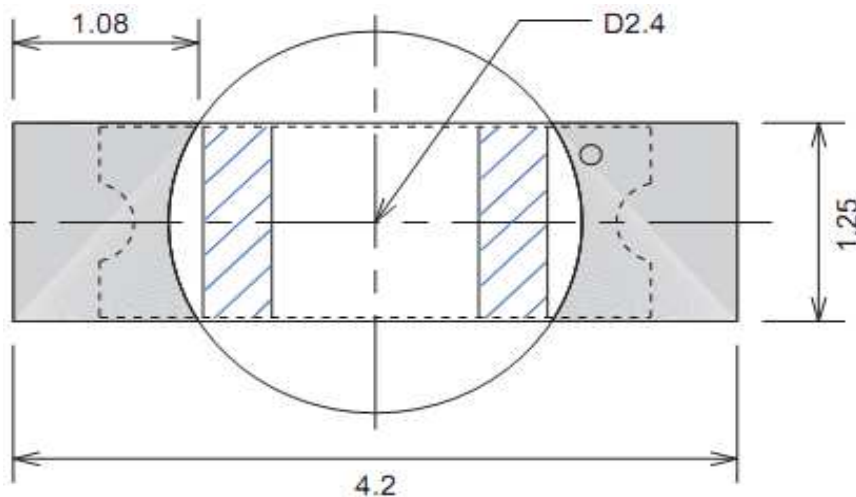

**Notes :**

All dimensions in mm tolerance is  $\pm 0.1\text{mm}$  unless otherwise noted.

<b>SMT Top View LED Blue</b>	
Part No.:	<b>M11B9013</b>
Customer:	

DRW:	Wang	CHKD	Wung	MATL:	Chui	DATE	03.12.2009
APPD:	Ping			FINISH	Dia	Sheet	1 from 9

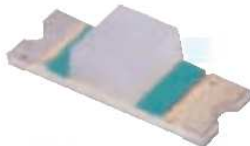

**Absolute Maximum Ratings**

Ta=25°C

Item	Symbol	InGaN	Unit
Power Dissipation	P <sub>D</sub>	78	mW
DC Forward Current	I <sub>F</sub>	20	mA
Pulsed Forward Current	I <sub>FP</sub> *	80	mA
Reverse Voltage	V <sub>R</sub>	5	V
Operating Temperature	T <sub>OP</sub>	-30 to 80	°C
Storage Temperature	T <sub>ST</sub>	-40 to 85	°C

\* 0.1 msec pulse, 10% duty cycle

**Electrical / Optical Characteristics**

I<sub>F</sub>=5mA Ta=25°C

Ermitting Color	Blue		
Material	InGaN		
Forward Voltage	typ.	2.8	V <sub>F</sub>
	max.	3.15	V <sub>F</sub>
Wavelength typ.	λ <sub>D</sub>	472	nm
	λ <sub>P</sub>	470	nm
	Δλ	40	nm
Color Temperature	min.	---	K
	max.	---	K
Luminous Intensity *	min.	9	mcd
	typ.	25	mcd
Reverse Current	max.	---	μA
Viewing Angle	2Θ1/2	140	

\* Per NIST standards

**SMT Top View LED  
Blue**

Part No.: **M11B9013**

Customer:

DRW:	Wang	CHKD	Wung	MATL:	Chui	DATE	03.12.2009
APPD:	Ping			FINISH	Dia	Sheet	2 from 9

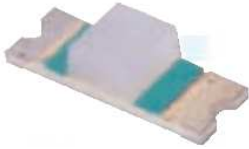

**Directive Characteristics**

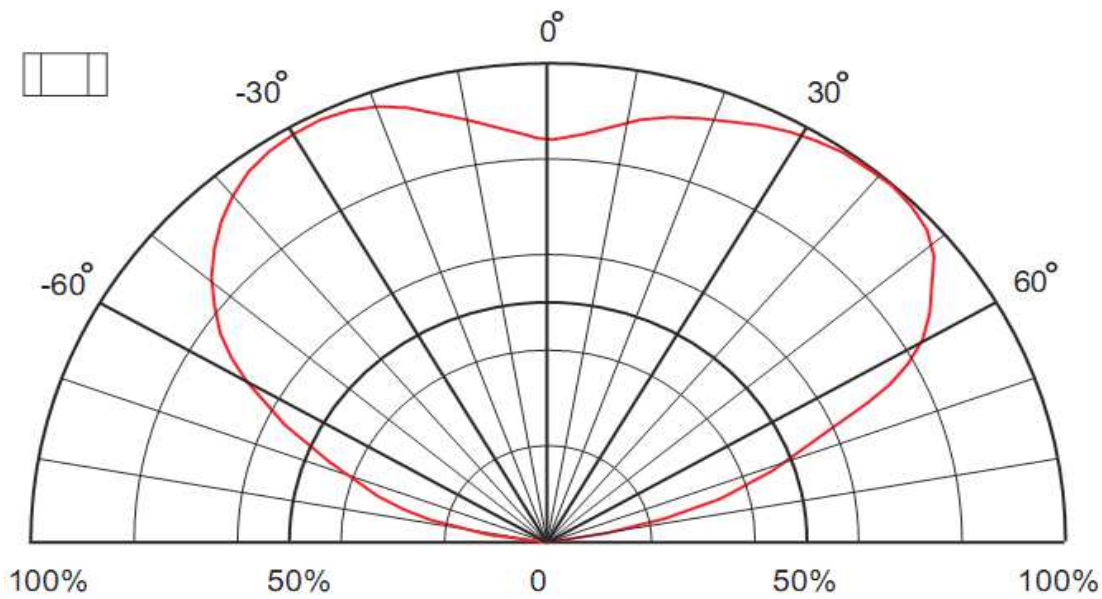
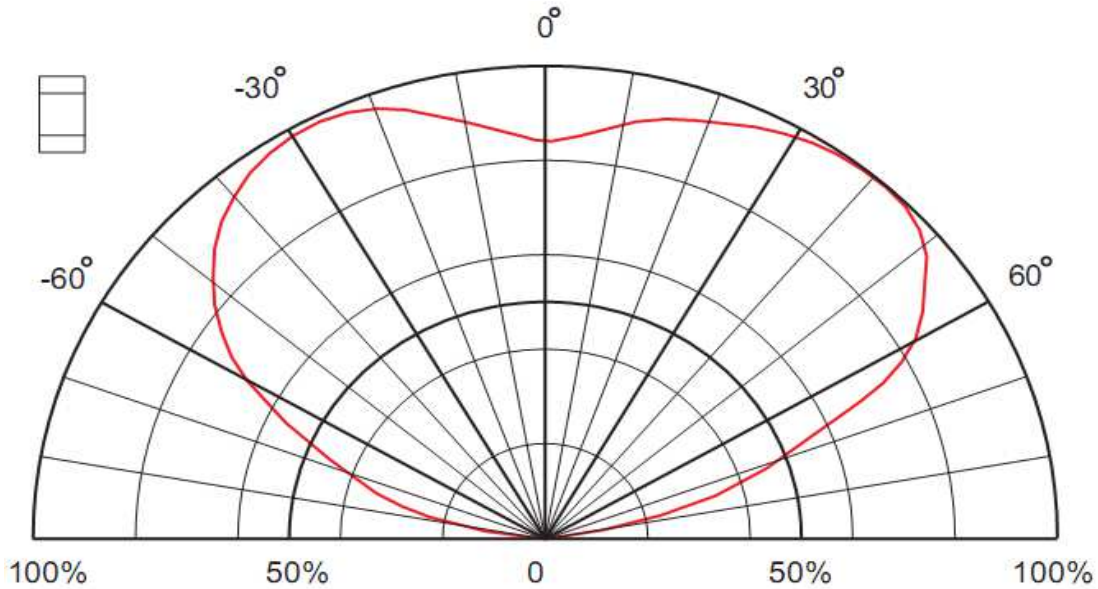

<b>SMT Top View LED Blue</b>	
Part No.:	<b>M11B9013</b>
Customer:	

DRW:	Wang	CHKD	Wung	MATL:	Chui	DATE	03.12.2009
APPD:	Ping			FINISH	Dia	Sheet	3 from 9

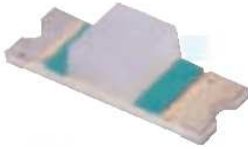

**Curvs**

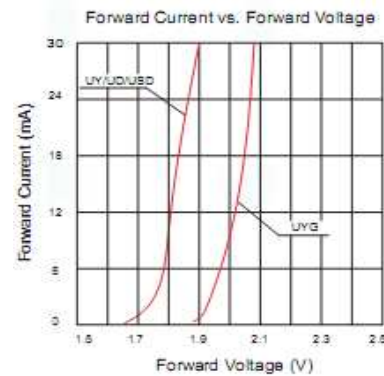
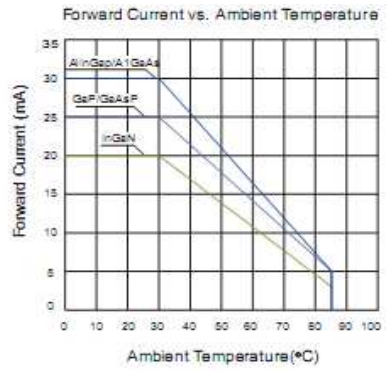
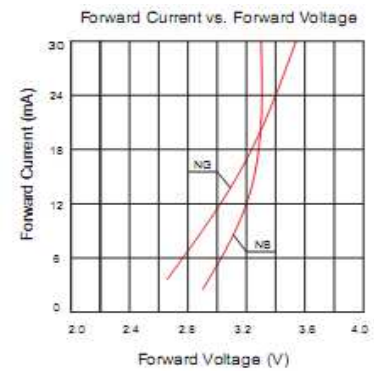
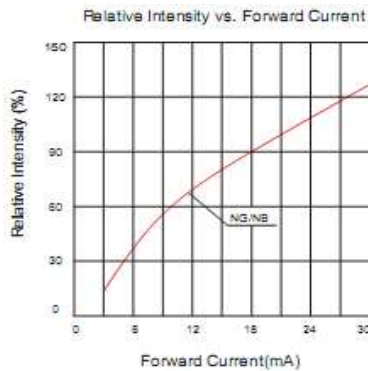
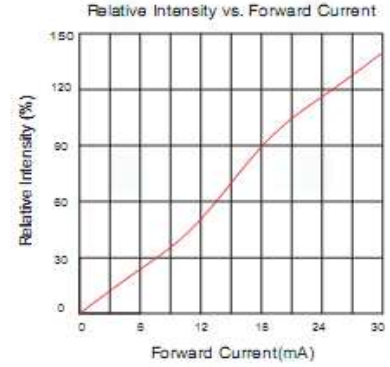
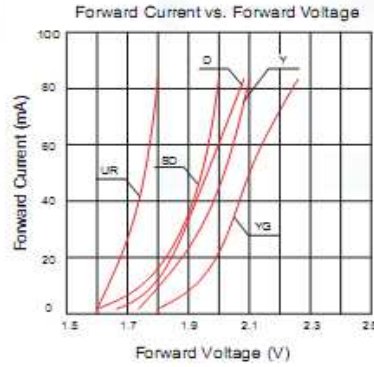
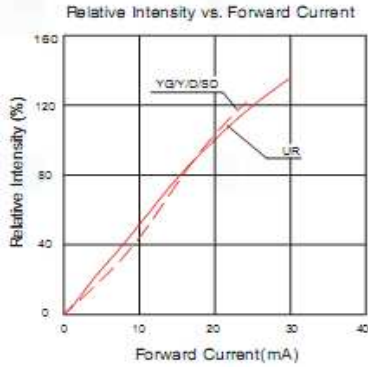

**SMT Top View LED Blue**

Part No.: **M11B9013**

Customer:

DRW:	Wang	CHKD	Wung	MATL:	Chui	DATE	03.12.2009
APPD:	Ping			FINISH	Dia	Sheet	4 from 9

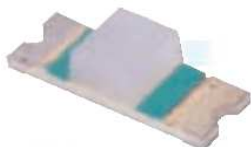

**Solder Condition**

**Lead Free Solder**

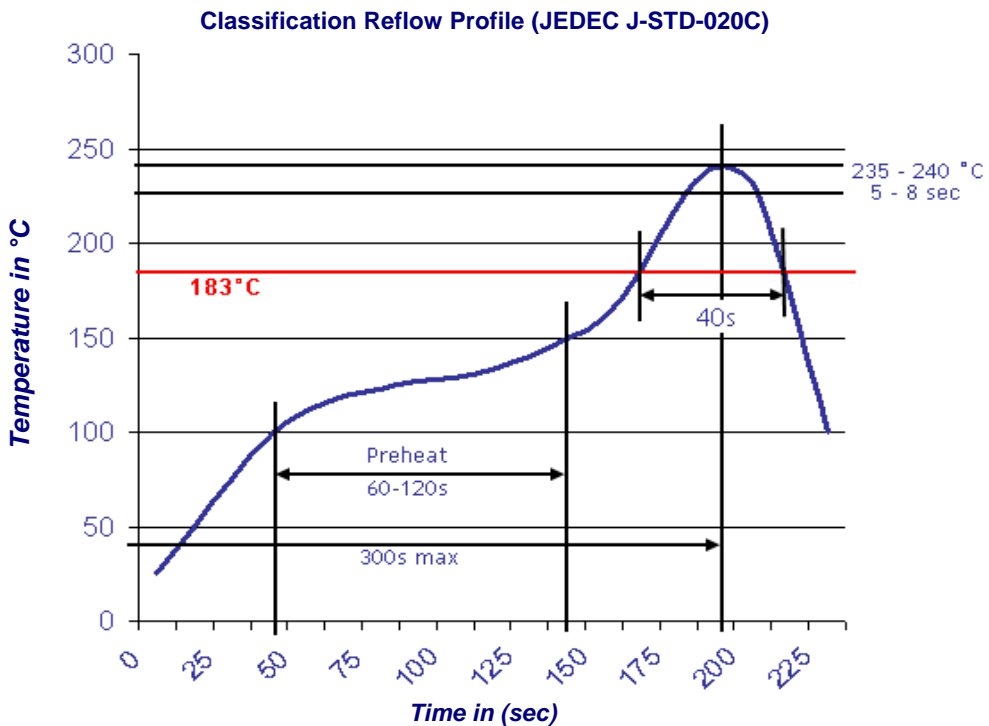

<b>SMT Top View LED Blue</b>	
Part No.:	<b>M11B9013</b>
Customer:	

DRW:	Wang	CHKD	Wung	MATL:	Chui	DATE	03.12.2009
APPD:	Ping			FINISH	Dia	Sheet	5 from 9



**Packing Specifications**

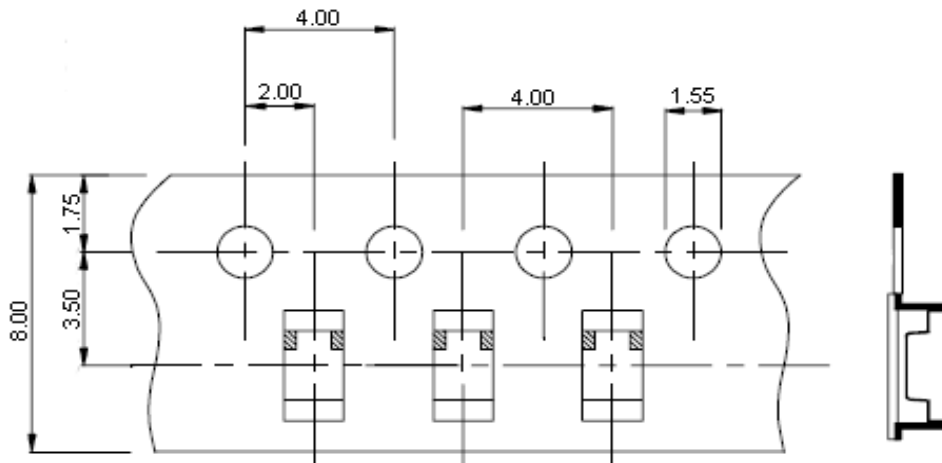

**Reel Specifications**



**SMT Top View LED  
 Blue**

Part No.: **M11B9013**

Customer:

DRW:	Wang	CHKD	Wung	MATL:	Chui	DATE	03.12.2009
APPD:	Ping			FINISH	Dia	Sheet	6 from 9

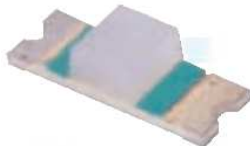

**Handling Precautions**

Compare to epoxy encapsulant that is hard and brittle, silicone is softer and flexible. Although its characteristic significantly reduces thermal stress, it is more susceptible to damage by external mechanical force. As a result, special handling precautions need to be observed during assembly using silicone encapsulated LED products. Failure to comply might lead to damage and premature failure of the LED.

1. Handle the component along the side surfaces by using forceps or appropriate tools

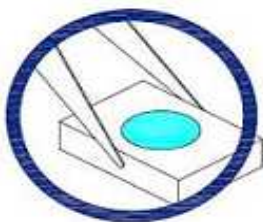

2. Do not directly touch or handle the silicone lens surface. It may damage the internal circuitry.



3. Do not stack together assembled PCBs containing exposed LEDs. Outside impact may scratch the silicone lens or damage the internal circuitry.



<b>SMT Top View LED Blue</b>	
Part No.:	<b>M11B9013</b>
Customer:	

DRW:	Wang	CHKD	Wung	MATL:	Chui	DATE	03.12.2009
APPD:	Ping			FINISH	Dia	Sheet	7 from 9

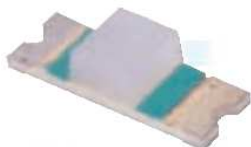

4. The outer diameter of the TOP LED pickup nozzle should not exceed the size of the LED to prevent air leaks. The inner diameter of the nozzle should be as large as possible.
5. A pliable material is suggested for the nozzle tip to avoid scratching or damaging the LED surface during pickup.
6. The dimensions of the component must be accurately programmed in the pick-and-place machine to insure precise pickup and avoid damage during production.

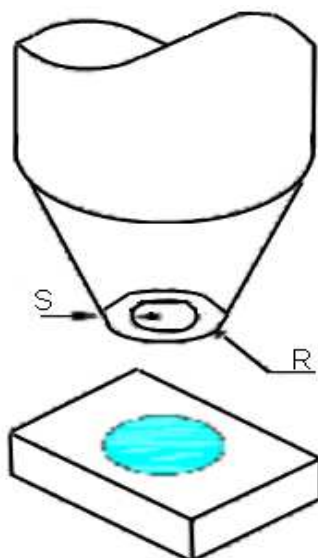

**SMT Top View LED  
 Blue**

Part No.: **M11B9013**

Customer:

DRW:	Wang	CHKD	Wung	MATL:	Chui	DATE	03.12.2009
APPD:	Ping			FINISH	Dia	Sheet	8 from 9



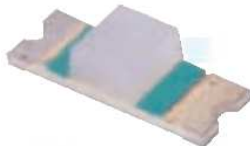

**Color table curve**

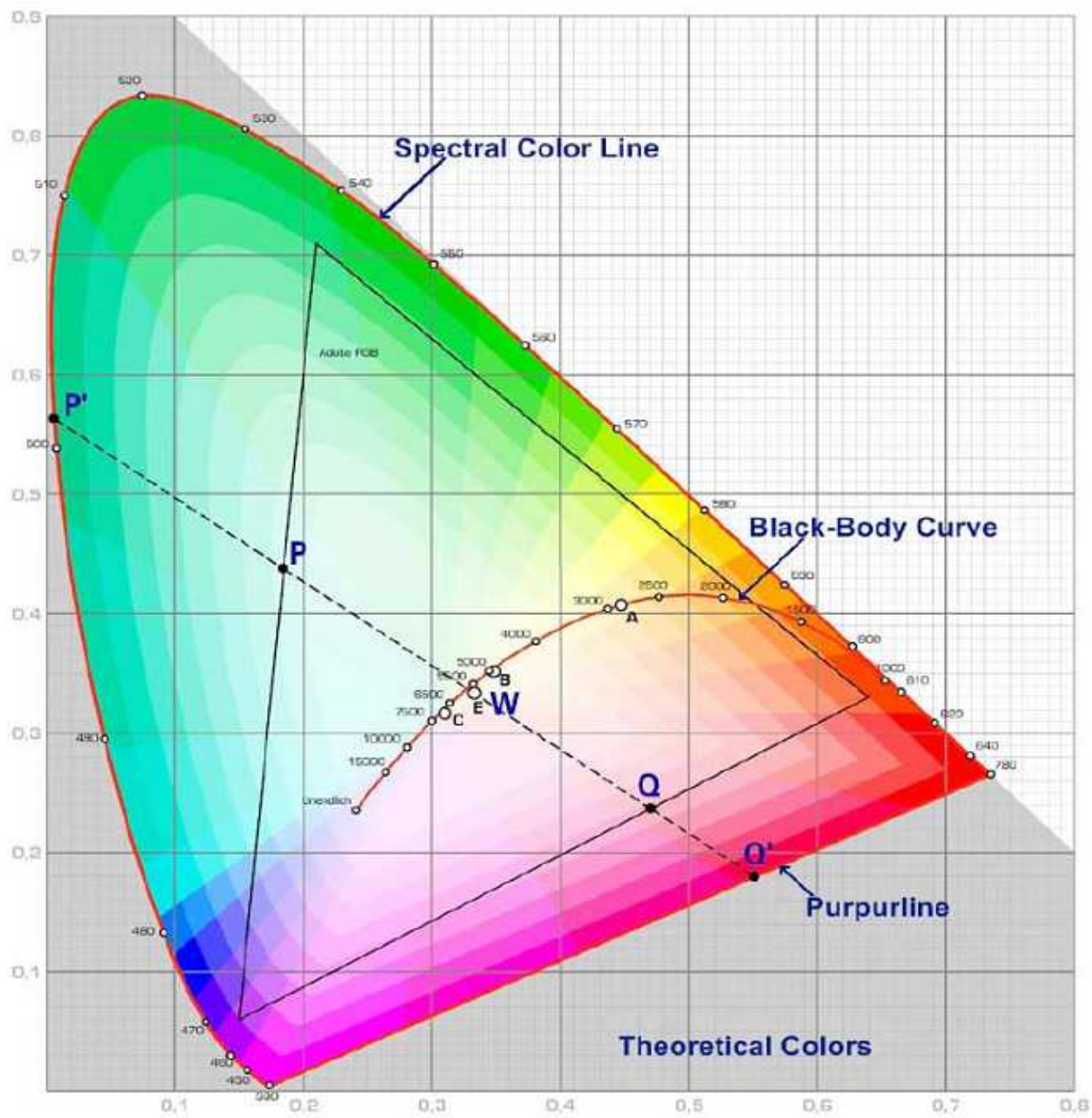

<b>SMT Top View LED Blue</b>	
Part No.:	<b>M11B9013</b>
Customer:	

DRW:	Wang	CHKD	Wung	MATL:	Chui	DATE	03.12.2009
APPD:	Ping			FINISH	Dia	Sheet	9 from 9

Copyright by EDCON-COMPONENTS