

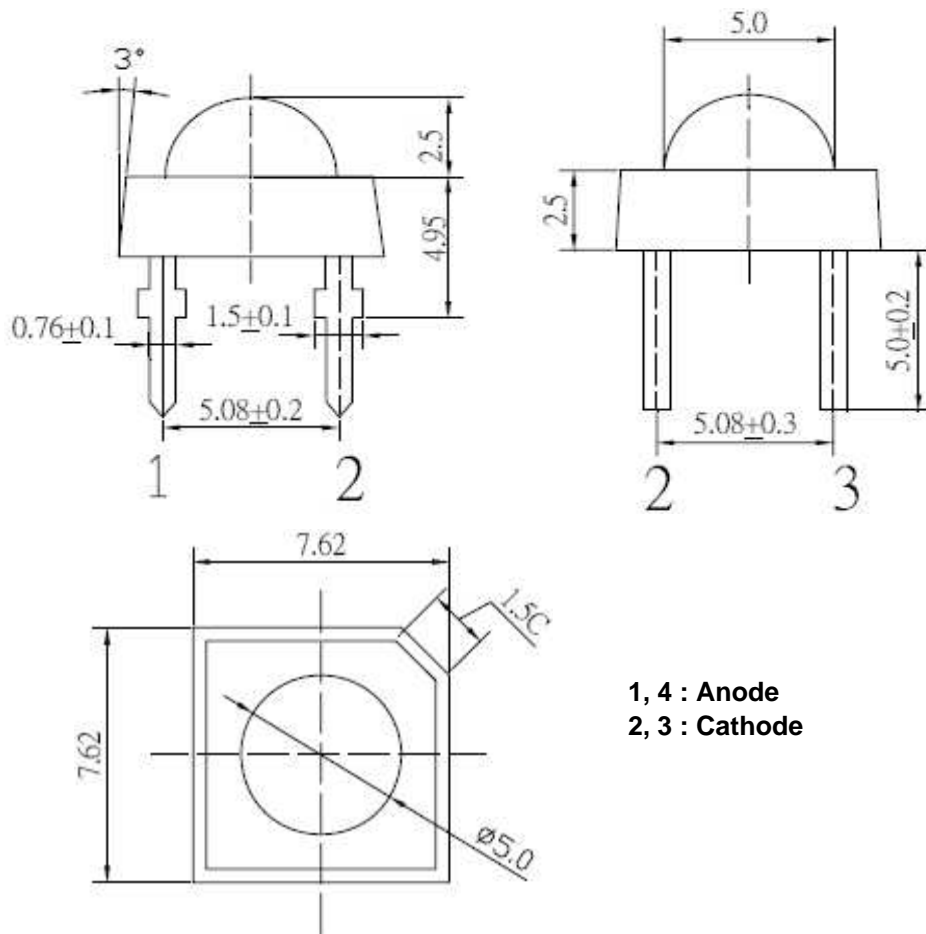

Applications

- Electronic Signs and Signals
- Small Area Illuminations
 - Back Lighting
 - Other Lighting

Technical Drawing



1, 4 : Anode
 2, 3 : Cathode

Notes :

All dimensions in mm tolerance is ± 0.1 mm unless otherwise noted.

| | |
|---------------------------|-----------------|
| Super Flux Red | |
| Part No.: | M13K2033 |
| Customer: | |

| | | | | | | | |
|-------|------|------|-------|--------|------|-------|------------|
| DRW: | Dong | CHKD | Chang | MATL: | Chui | DATE | 16.11.2010 |
| APPD: | Ping | | | FINISH | Hui | Sheet | 1 from 6 |



Absolute Maximum Ratings

| <i>Item</i> | <i>Symbol</i> | <i>---</i> | <i>Unit</i> |
|------------------------|-------------------|------------|-------------|
| Power Dissipation | P _D | 130 | mW |
| DC Forward Current | I _F | 50 | mA |
| Pulsed Forward Current | I _{FP} * | 120 | mA |
| Reverse Voltage | V _R | 5 | V |
| Operating Temperature | T _{OP} | -30 to 85 | °C |
| Storage Temperature | T _{ST} | -40 to 100 | °C |

* 0.1 msec pulse, 10% duty cycle

Electrcal / Optical Characteristics

| | | | |
|-----------------------------|----------------|-----------|----------------|
| Emitting Color | Red | | |
| Material | --- | | |
| Forward Voltage | typ. | 2.1 | V _F |
| | max. | 2.6 | V _F |
| Wavelength typ. | λ _D | 620 ~ 630 | nm |
| | λ _P | --- | nm |
| | Δλ | --- | nm |
| Color Temperature | min. | --- | K |
| | max. | --- | K |
| Luminous Intensity * | min. | 3000 | mcd |
| | typ. | 4000 | mcd |
| Reverse Current | max. | --- | μA |
| Viewing Angle | 2θ1/2 | 120 | |

* Per NIST standards

**Super Flux
Red**

Part No.: **M13K2033**

Customer:

| | | | | | | | |
|-------|------|------|-------|--------|------|-------|------------|
| DRW: | Dong | CHKD | Chang | MATL: | Chui | DATE | 16.11.2010 |
| APPD: | Ping | | | FINISH | Hui | Sheet | 2 from 6 |



Directive Characteristics

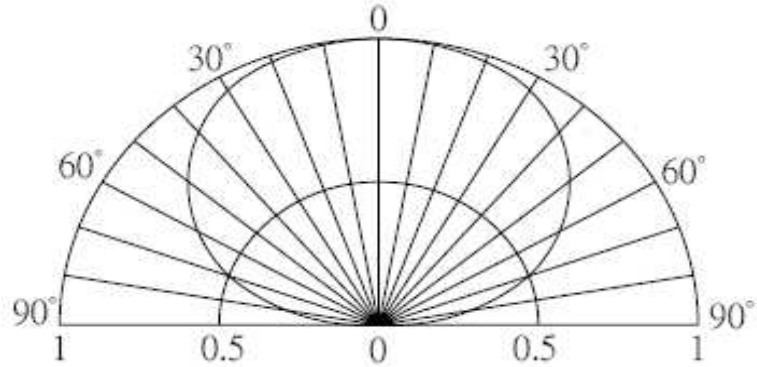

| | |
|---------------------------|-----------------|
| Super Flux Red | |
| Part No.: | M13K2033 |
| Customer: | |

| | | | | | | | |
|-------|------|------|-------|--------|------|-------|------------|
| DRW: | Dong | CHKD | Chang | MATL: | Chui | DATE | 16.11.2010 |
| APPD: | Ping | | | FINISH | Hui | Sheet | 3 from 6 |



Typical Characteristics

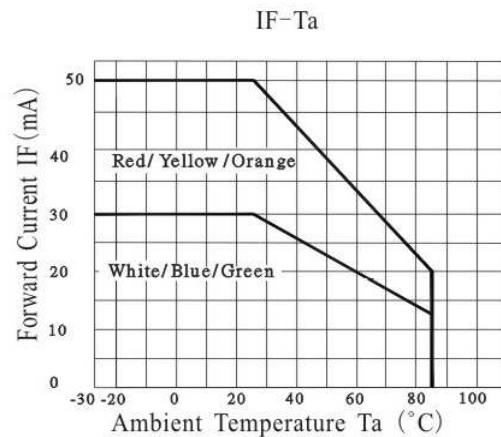
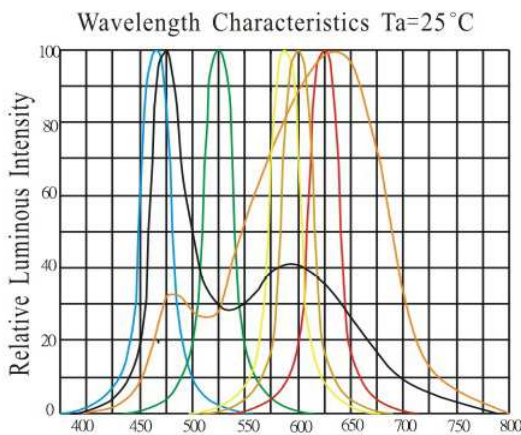
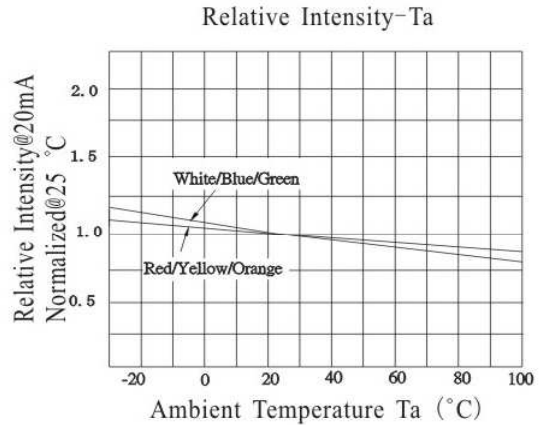
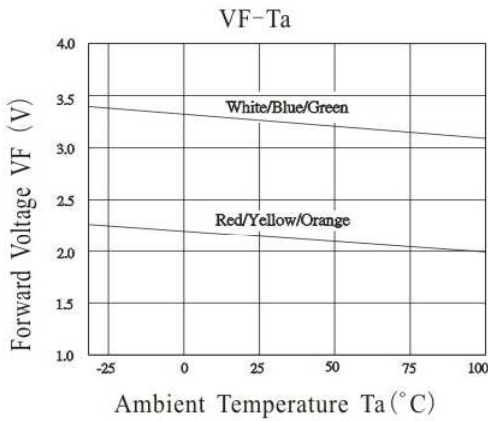
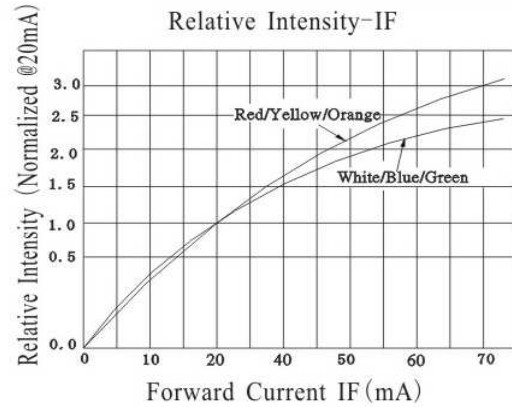
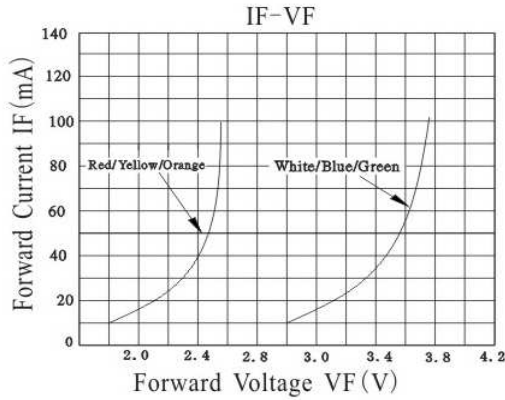

| | |
|---------------------------|-----------------|
| Super Flux Red | |
| Part No.: | M13K2033 |
| Customer: | |

| | | | | | | | |
|-------|------|------|-------|--------|------|-------|------------|
| DRW: | Dong | CHKD | Chang | MATL: | Chui | DATE | 16.11.2010 |
| APPD: | Ping | | | FINISH | Hui | Sheet | 4 from 6 |



Solder Condition

Lead Free Solder

Classification Reflow Profile (JEDEC J-STD-020C)

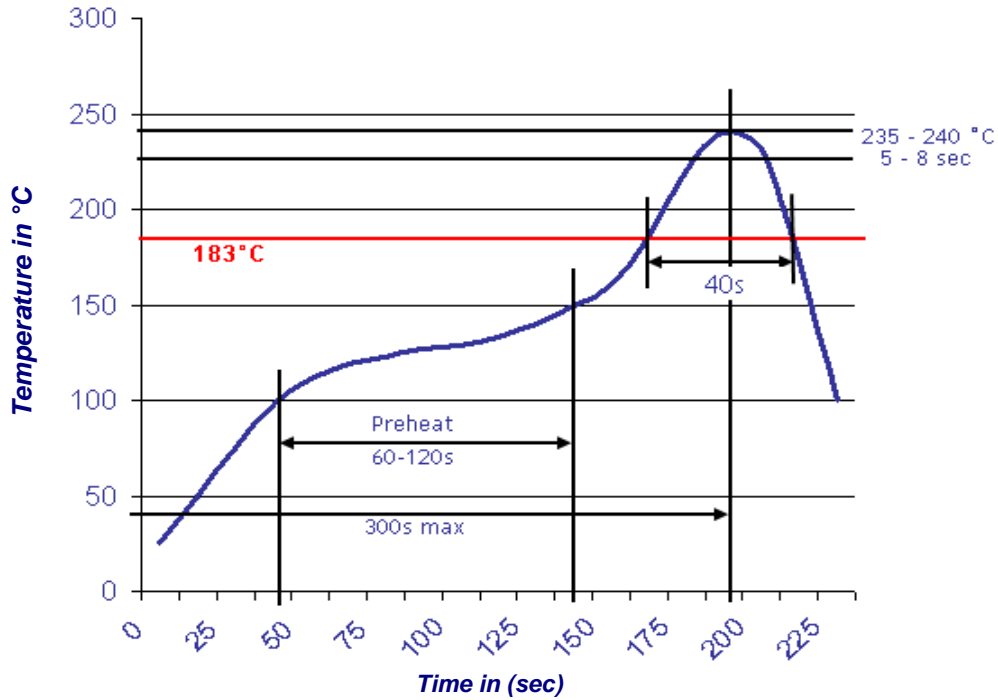

| | |
|---------------------------|-----------------|
| Super Flux Red | |
| Part No.: | M13K2033 |
| Customer: | |

| | | | | | | | |
|-------|------|------|-------|--------|------|-------|------------|
| DRW: | Dong | CHKD | Chang | MATL: | Chui | DATE | 16.11.2010 |
| APPD: | Ping | | | FINISH | Hui | Sheet | 5 from 6 |



Color table curve

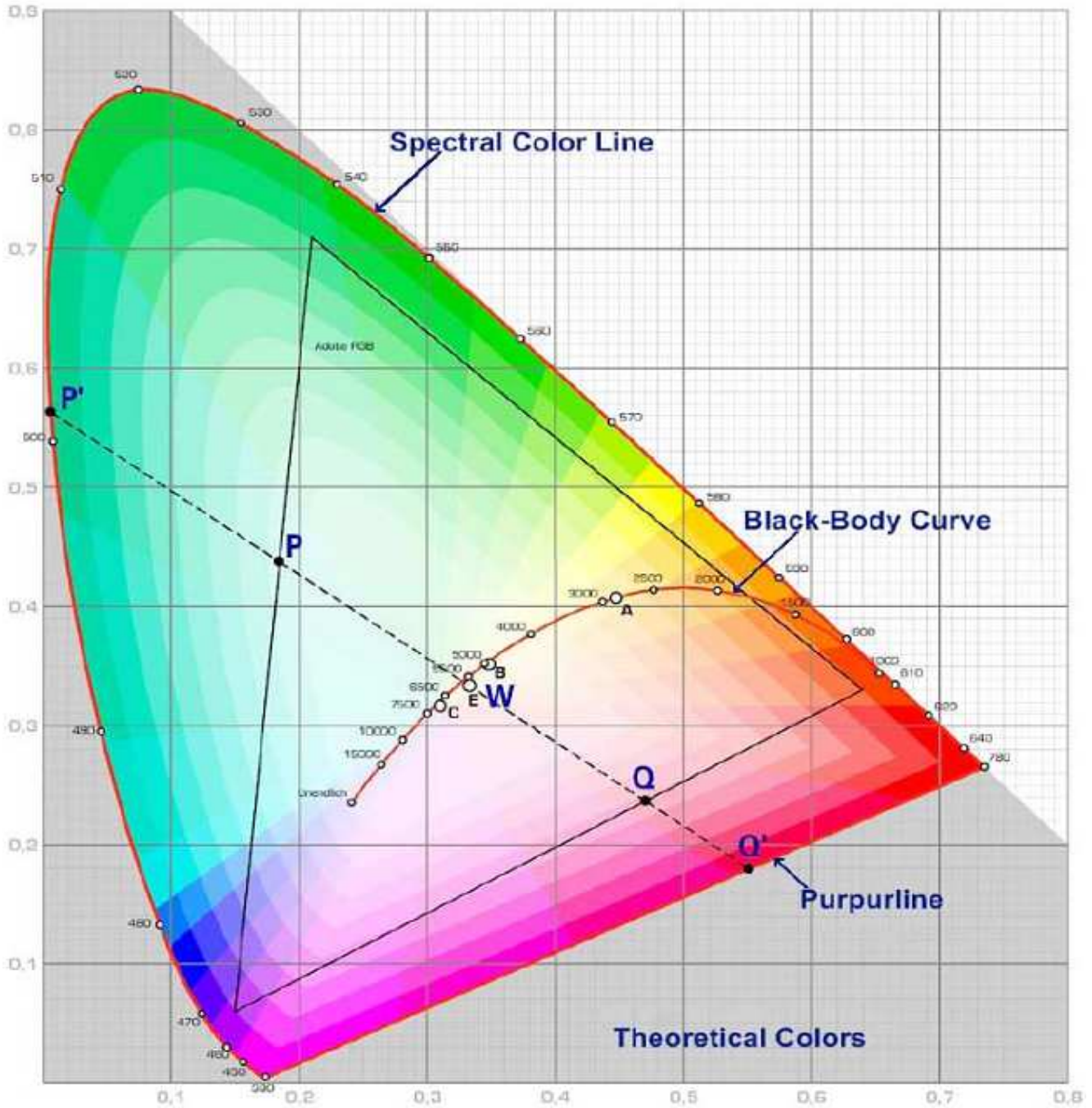

| | |
|---------------------------|-----------------|
| Super Flux Red | |
| Part No.: | M13K2033 |
| Customer: | |

| | | | | | | | |
|-------|------|------|-------|--------|------|-------|------------|
| DRW: | Dong | CHKD | Chang | MATL: | Chui | DATE | 16.11.2010 |
| APPD: | Ping | | | FINISH | Hui | Sheet | 6 from 6 |