

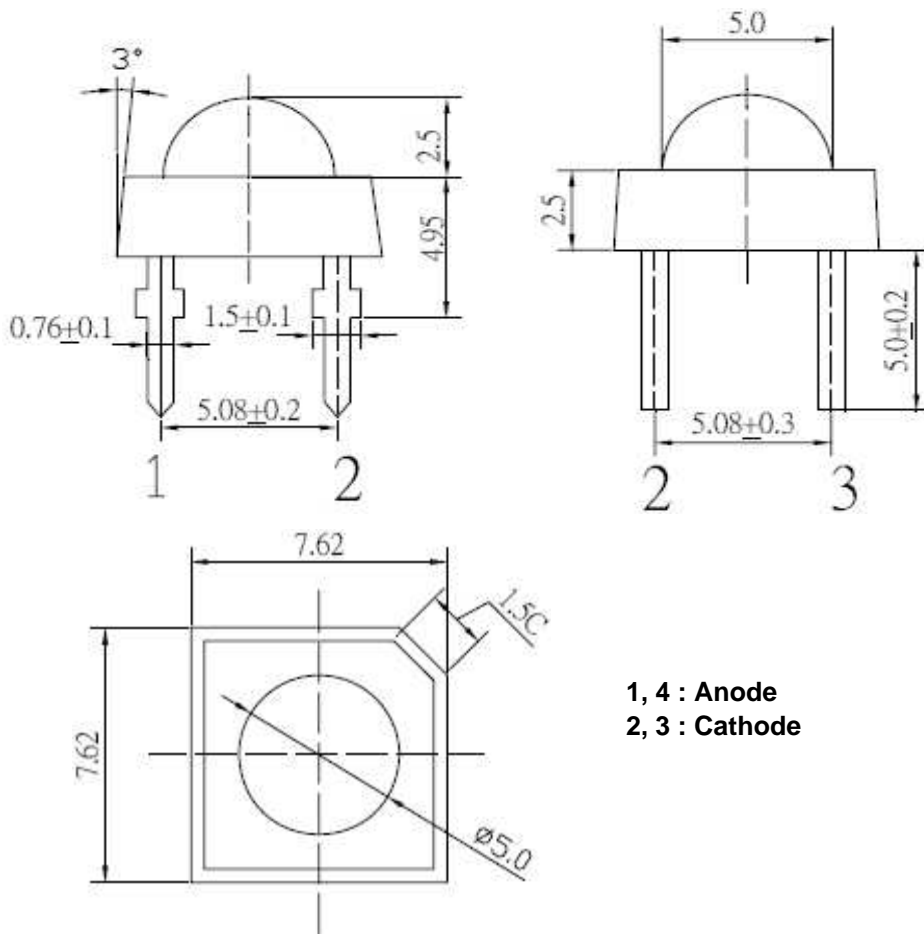

**Applications**

- Electronic Signs and Signals
- Small Area Illuminations
  - Back Lighting
  - Other Lighting

**Technical Drawing**



1, 4 : Anode  
 2, 3 : Cathode

**Notes :**

All dimensions in mm tolerance is  $\pm 0.1$ mm unless otherwise noted.

<b>Super Flux Blue</b>	
Part No.:	<b>M13K2031</b>
Customer:	

DRW:	Dong	CHKD	Chang	MATL:	Chui	DATE	16.11.2010
APPD:	Ping			FINISH	Hui	Sheet	1 from 6



**Absolute Maximum Ratings**

<i>Item</i>	<i>Symbol</i>	<i>---</i>	<i>Unit</i>
Power Dissipation	P <sub>D</sub>	180	mW
DC Forward Current	I <sub>F</sub>	50	mA
Pulsed Forward Current	I <sub>FP</sub> *	100	mA
Reverse Voltage	V <sub>R</sub>	5	V
Operating Temperature	T <sub>OP</sub>	-30 to 85	°C
Storage Temperature	T <sub>ST</sub>	-40 to 100	°C

\* 0.1 msec pulse, 10% duty cycle

**Electrcal / Optical Characteristics**

<b>Emitting Color</b>	Blue		
<b>Material</b>	---		
<b>Forward Voltage</b>	typ.	3.1	V <sub>F</sub>
	max.	3.6	V <sub>F</sub>
<b>Wavelength typ.</b>	λ <sub>D</sub>	465 ~ 475	nm
	λ <sub>P</sub>	---	nm
	Δλ	---	nm
<b>Color Temperature</b>	min.	---	K
	max.	---	K
<b>Luminous Intensity *</b>	min.	2180	mcd
	typ.	3000	mcd
<b>Reverse Current</b>	max.	---	μA
<b>Viewing Angle</b>	2θ1/2	120	

\* Per NIST standards

**Super Flux  
Blue**

Part No.: **M13K2031**

Customer:

DRW:	Dong	CHKD	Chang	MATL:	Chui	DATE	16.11.2010
APPD:	Ping			FINISH	Hui	Sheet	2 from 6



**Directive Characteristics**

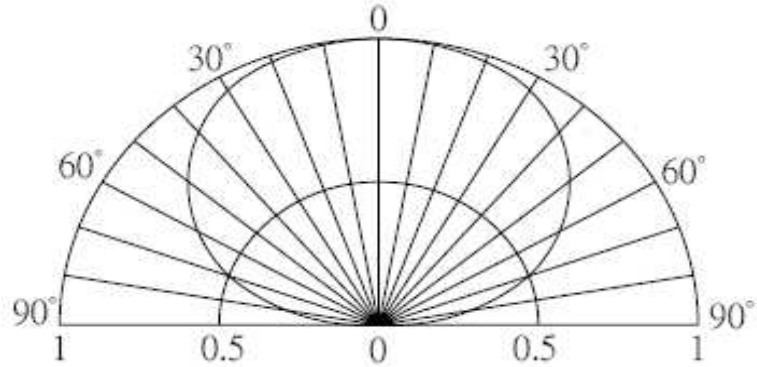

<b>Super Flux Blue</b>	
Part No.:	<b>M13K2031</b>
Customer:	

DRW:	Dong	CHKD	Chang	MATL:	Chui	DATE	16.11.2010
APPD:	Ping			FINISH	Hui	Sheet	3 from 6



**Typical Characteristics**

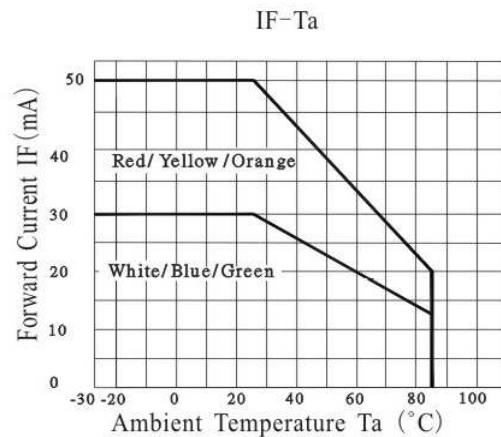
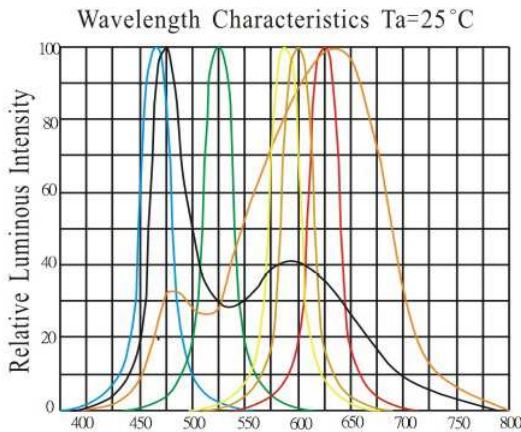
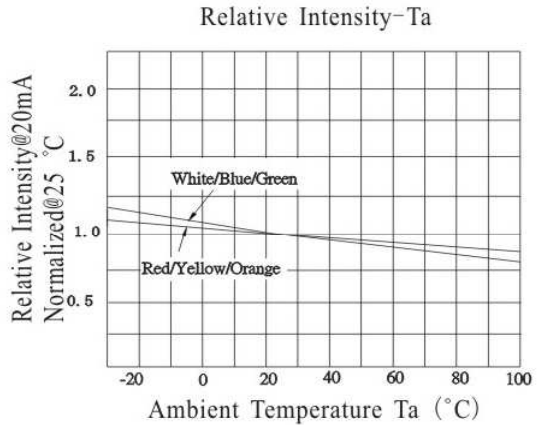
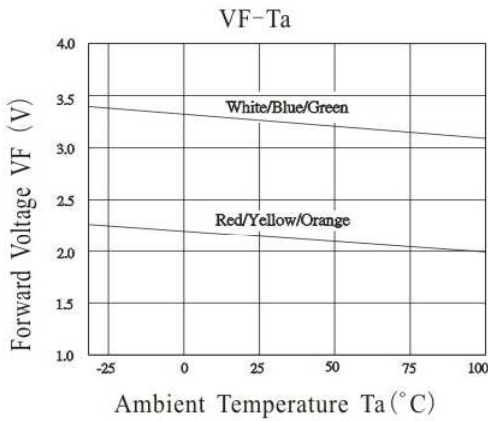
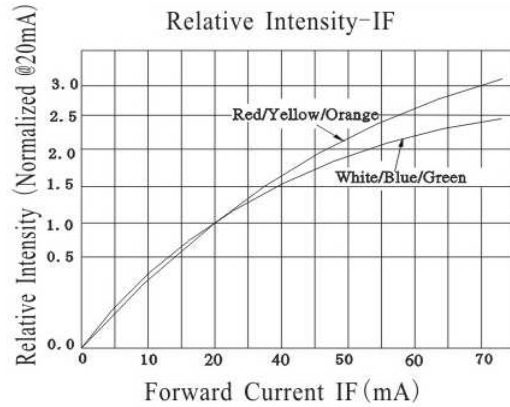
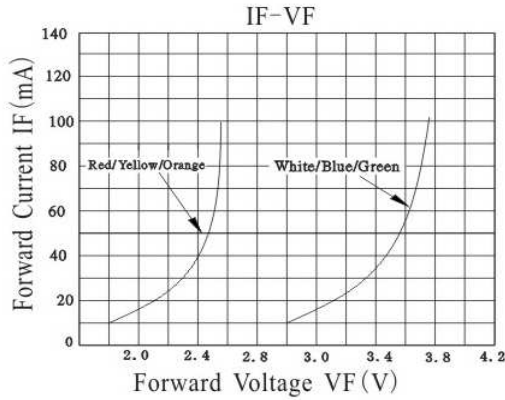

<b>Super Flux Blue</b>	
Part No.:	<b>M13K2031</b>
Customer:	

DRW:	Dong	CHKD	Chang	MATL:	Chui	DATE	16.11.2010
APPD:	Ping			FINISH	Hui	Sheet	4 from 6



**Solder Condition**

**Lead Free Solder**

**Classification Reflow Profile (JEDEC J-STD-020C)**

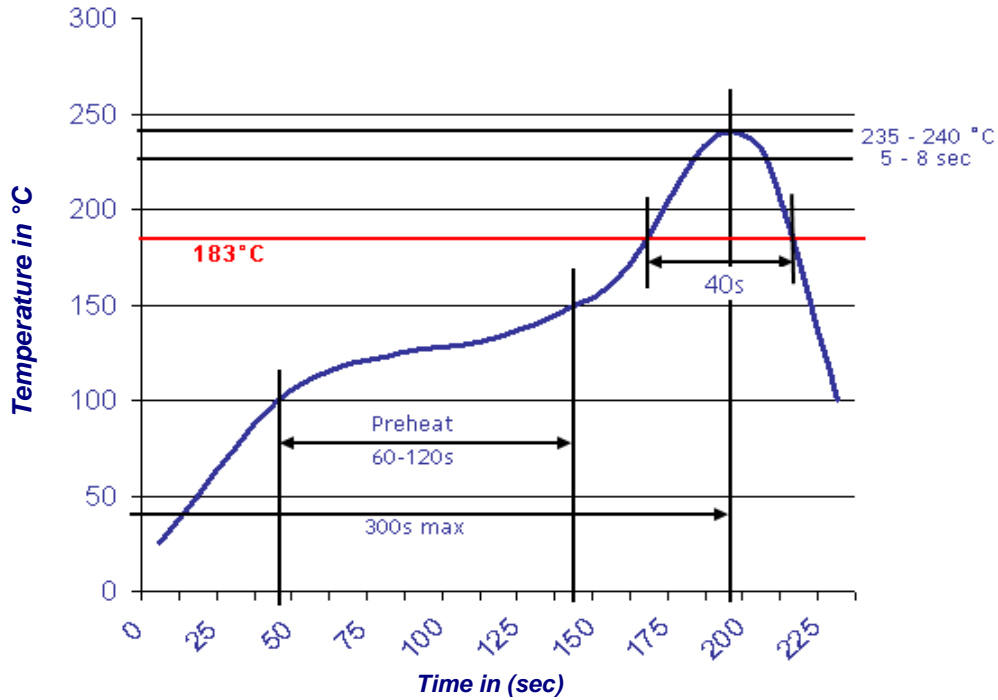

<b>Super Flux Blue</b>	
Part No.:	<b>M13K2031</b>
Customer:	

DRW:	Dong	CHKD	Chang	MATL:	Chui	DATE	16.11.2010
APPD:	Ping			FINISH	Hui	Sheet	5 from 6



**Color table curve**

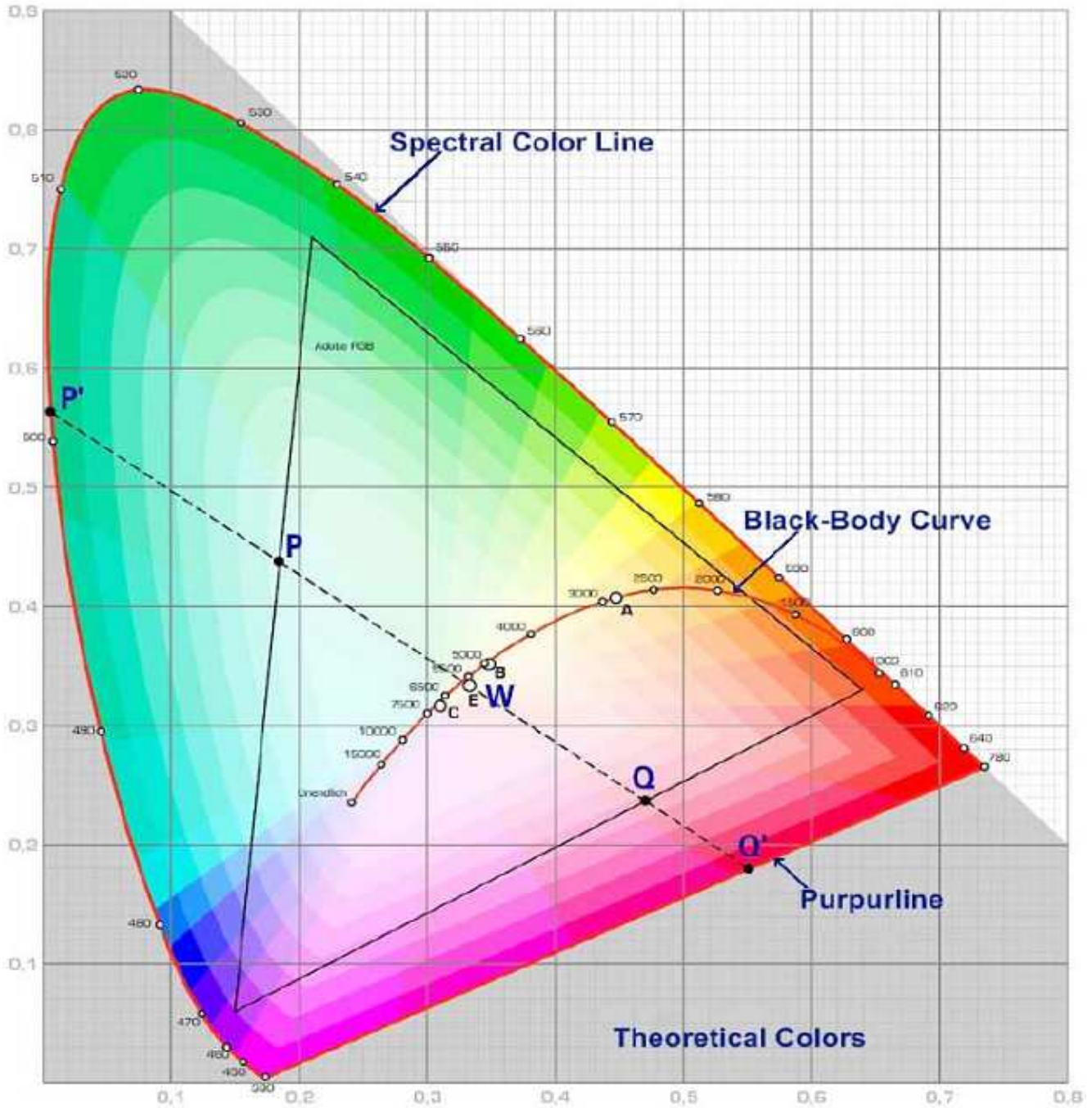

<b>Super Flux Blue</b>	
Part No.:	<b>M13K2031</b>
Customer:	

DRW:	Dong	CHKD	Chang	MATL:	Chui	DATE	16.11.2010
APPD:	Ping			FINISH	Hui	Sheet	6 from 6