

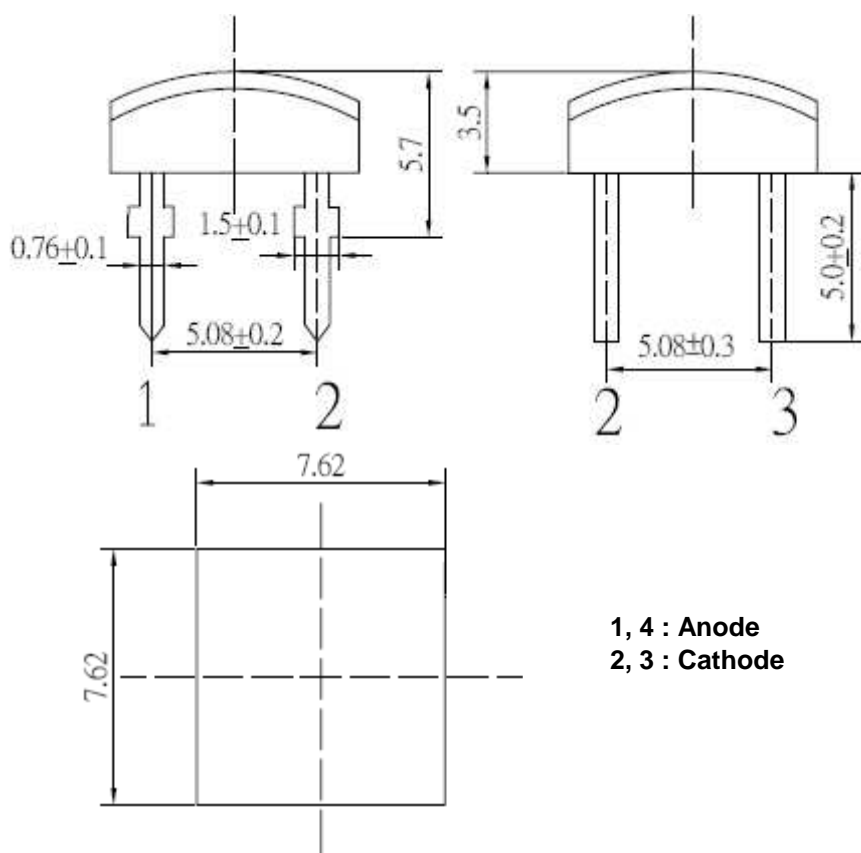

Applications

- Electronic Signs and Signals
- Small Area Illuminations
- Back Lighting
- Other Lighting

Technical Drawing



1, 4 : Anode
2, 3 : Cathode

Notes :

All dimensions in mm tolerance is ± 0.1mm unless otherwise noted.

Super Flux Green	
Part No.:	M13J9017
Customer:	

DRW:	Dong	CHKD	Chang	MATL:	Chui	DATE	07.12.2009
APPD:	Ping			FINISH	Hui	Sheet	1 from 6



Absolute Maximum Ratings

<i>Item</i>	<i>Symbol</i>	<i>---</i>	<i>Unit</i>
Power Dissipation	P _D	180	mW
DC Forward Current	I _F	50	mA
Pulsed Forward Current	I _{FP} *	100	mA
Reverse Voltage	V _R	5	V
Operating Temperature	T _{OP}	-30 to 85	°C
Storage Temperature	T _{ST}	-40 to 100	°C

* 0.1 msec pulse, 10% duty cycle

Electrical / Optical Characteristics

I_F=30mA

Emitting Color	Green		
Material	---		
Forward Voltage	typ.	3.1	V _F
	max.	3.6	V _F
Wavelength typ.	λ _D	520 ~ 530	nm
	λ _P	---	nm
	Δλ	---	nm
Color Temperature	min.	---	K
	max.	---	K
Luminous Intensity *	min.	3000	mcd
	typ.	4000	mcd
Reverse Current	max.	---	μA
Viewing Angle	2Θ1/2	140	

* Per NIST standards

Super Flux Green	
Part No.:	M13J9017
Customer:	

DRW:	Dong	CHKD	Chang	MATL:	Chui	DATE	07.12.2009
APPD:	Ping			FINISH	Hui	Sheet	2 from 6



Directive Characteristics

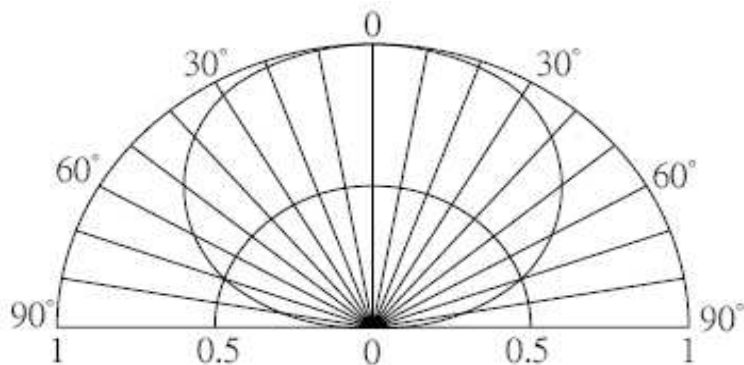

**Super Flux
Green**

Part No.: **M13J9017**

Customer:

DRW:	Dong	CHKD	Chang	MATL:	Chui	DATE	07.12.2009
APPD:	Ping			FINISH	Hui	Sheet	3 from 6

Copyright by EDCON-COMPONENTS



Typical Characteristics

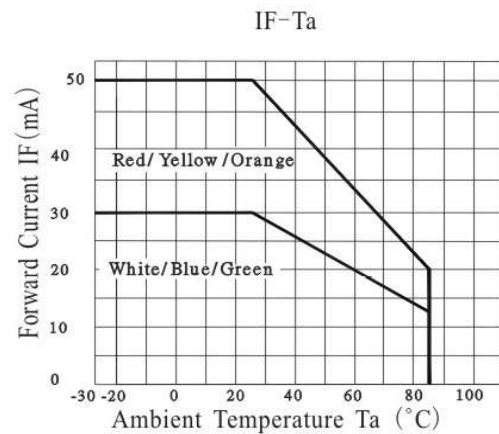
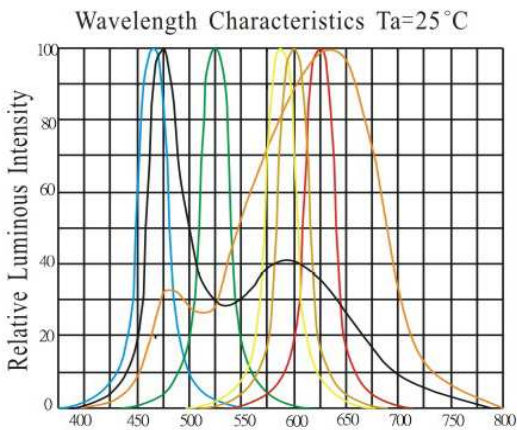
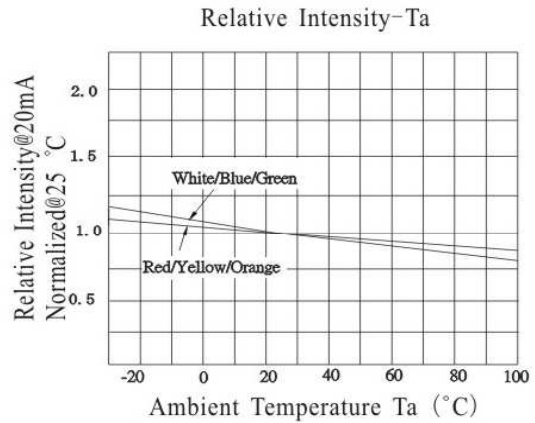
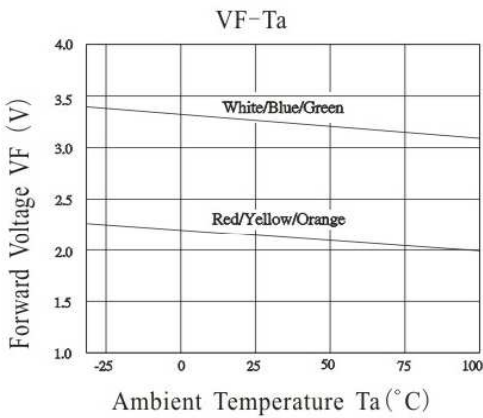
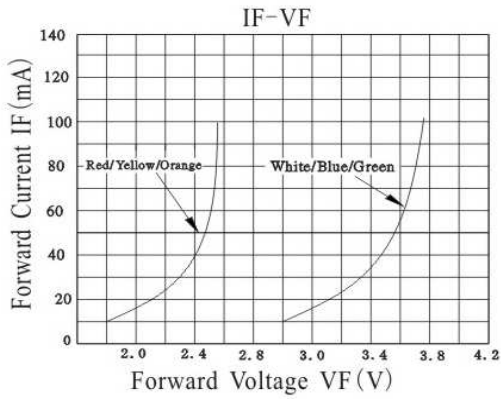

Super Flux Green	
Part No.:	M13J9017
Customer:	

DRW:	Dong	CHKD	Chang	MATL:	Chui	DATE	07.12.2009
APPD:	Ping			FINISH	Hui	Sheet	4 from 6



Solder Condition

Lead Free Solder

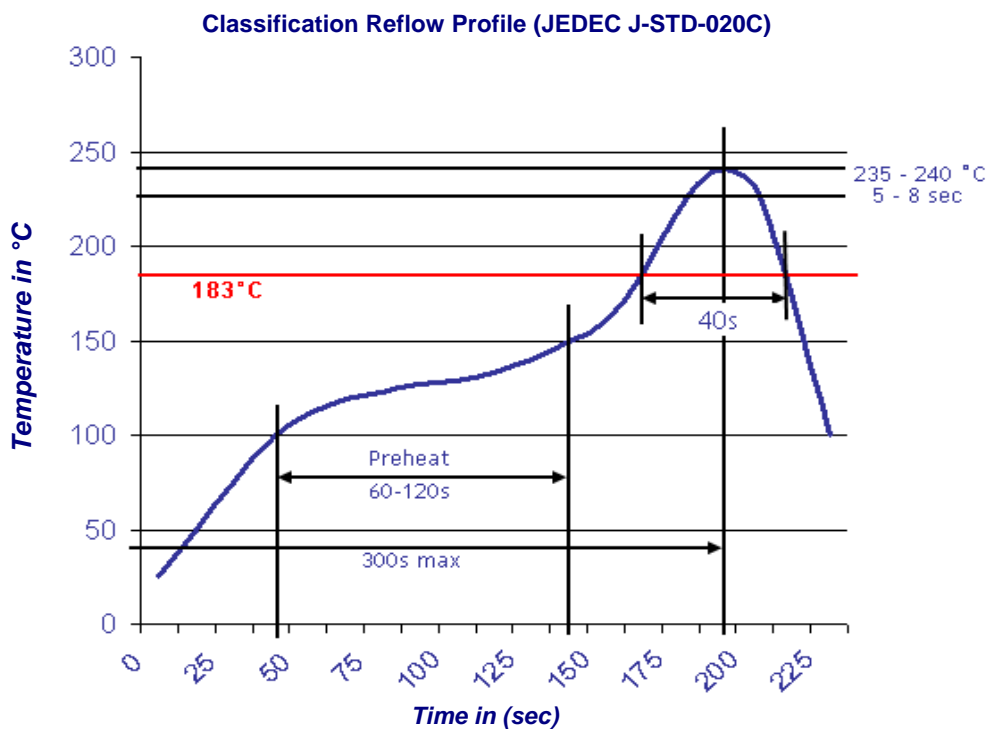

Super Flux Green	
Part No.:	M13J9017
Customer:	

DRW:	Dong	CHKD	Chang	MATL:	Chui	DATE	07.12.2009
APPD:	Ping			FINISH	Hui	Sheet	5 from 6



Color table curve

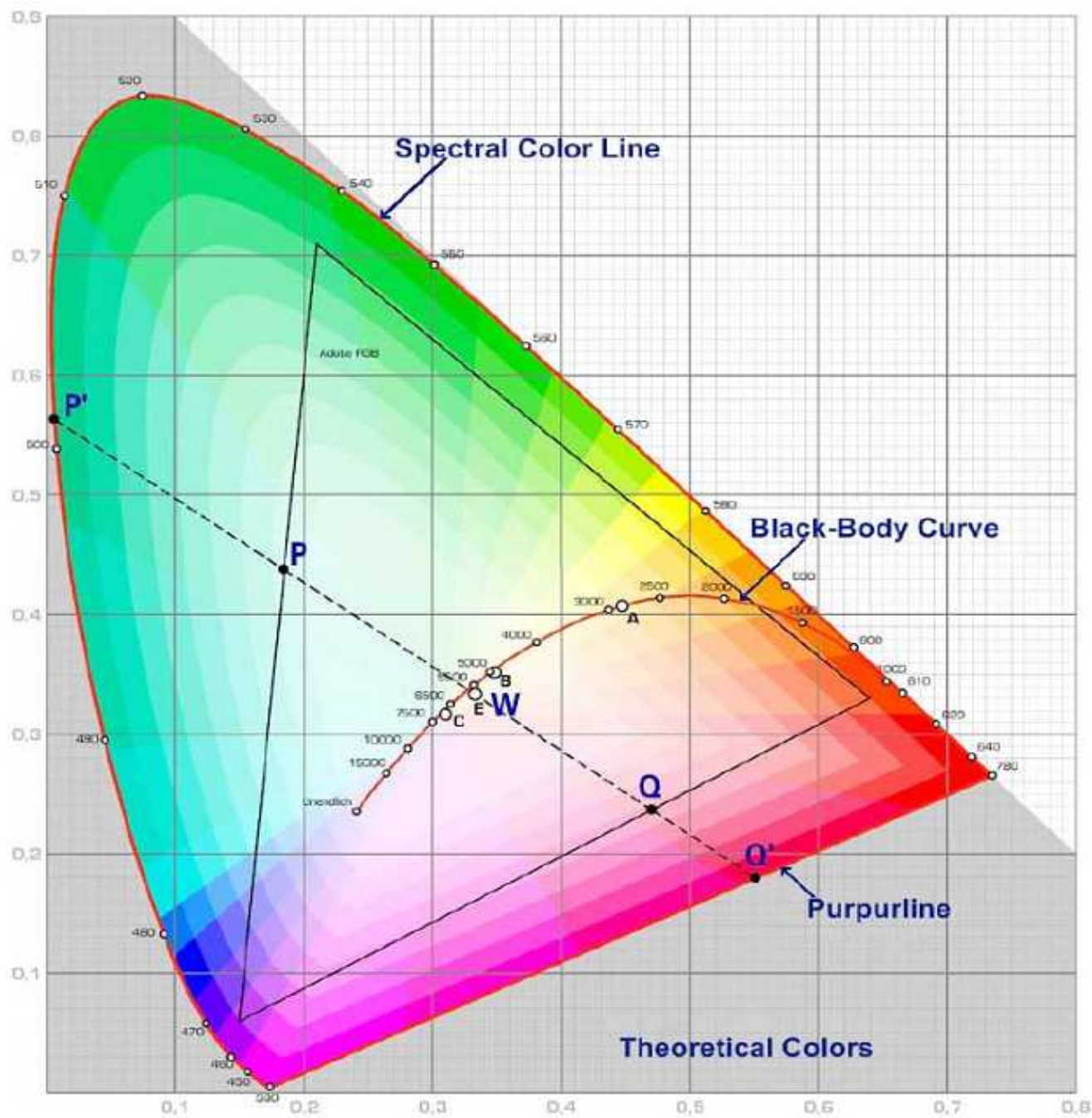

Super Flux Green	
Part No.:	M13J9017
Customer:	

DRW:	Dong	CHKD	Chang	MATL:	Chui	DATE	07.12.2009
APPD:	Ping			FINISH	Hui	Sheet	6 from 6

Copyright by EDCON-COMPONENTS