

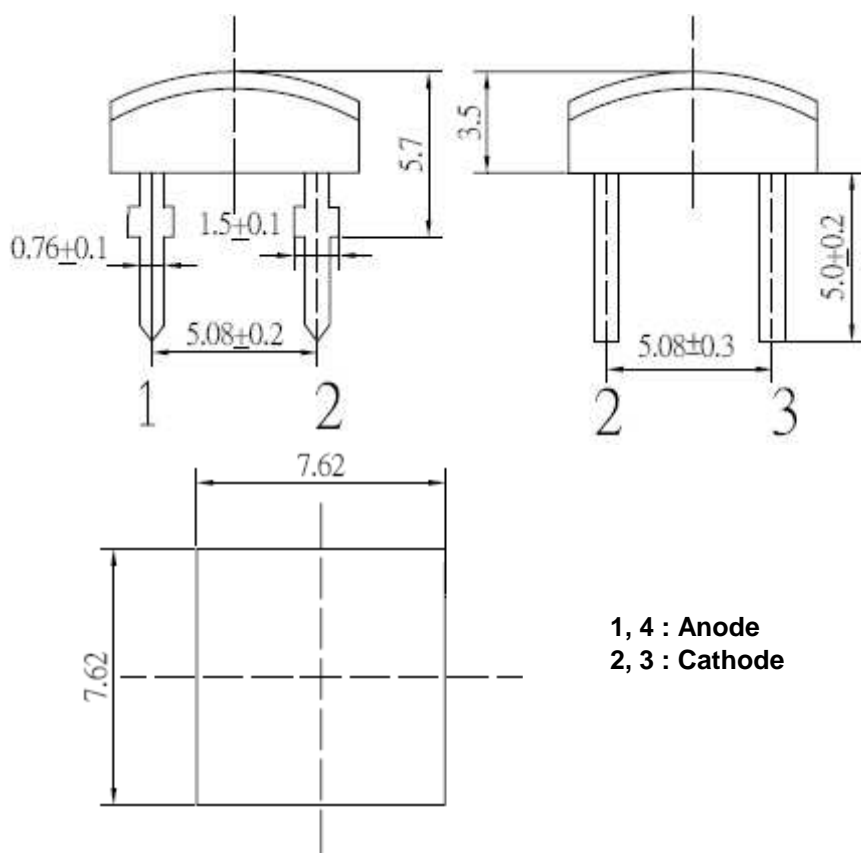

**Applications**

- Electronic Signs and Signals
- Small Area Illuminations
- Back Lighting
- Other Lighting

**Technical Drawing**



1, 4 : Anode  
 2, 3 : Cathode

**Notes :**

All dimensions in mm tolerance is ± 0.1mm unless otherwise noted.

<b>Super Flux Pure White</b>	
Part No.:	<b>M13J9013</b>
Customer:	

DRW:	Dong	CHKD	Chang	MATL:	Chui	DATE	07.12.2009
APPD:	Ping			FINISH	Hui	Sheet	1 from 6



### Absolute Maximum Ratings

Item	Symbol	---	Unit
Power Dissipation	$P_D$	150	mW
DC Forward Current	$I_F$	50	mA
Pulsed Forward Current	$I_{FP}^*$	100	mA
Reverse Voltage	$V_R$	5	V
Operating Temperature	$T_{OP}$	-30 to 85	°C
Storage Temperature	$T_{ST}$	-40 to 100	°C

\* 0.1 msec pulse, 10% duty cycle

### Electrical / Optical Characteristics

$I_F=30mA$

Ermitting Color	Pure White		
Material	---		
Forward Voltage	typ.	3.1	$V_F$
	max.	3.6	$V_F$
Wavelength typ.	$\lambda_D$	$x = 0.23 \sim 0.31$	nm
	$\lambda_P$	$y = 0.24 \sim 0.32$	nm
	$\Delta\lambda$	---	nm
Color Temperature	min.	---	K
	max.	---	K
Luminous Intensity *	min.	1560	mcd
	typ.	2000	mcd
Reverse Current	max.	---	$\mu A$
Viewing Angle	$2\theta_{1/2}$	140	

\* Per NIST standards

### Super Flux Pure White

Part No.: **M13J9013**

Customer:

DRW:	Dong	CHKD	Chang	MATL:	Chui	DATE	07.12.2009
APPD:	Ping			FINISH	Hui	Sheet	2 from 6

Copyright by EDCON-COMPONENTS



### Directive Characteristics

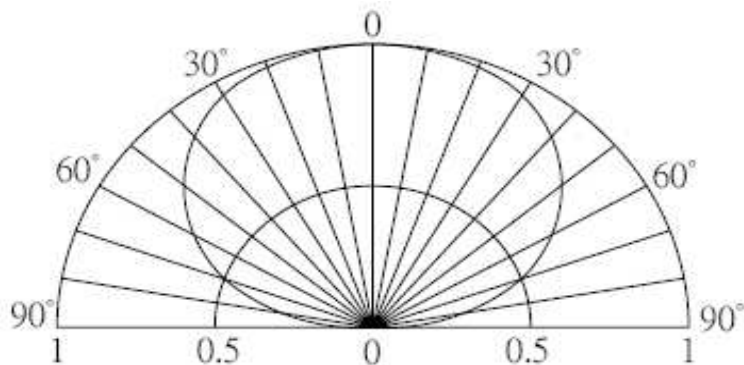

**Super Flux  
Pure White**

Part No.: **M13J9013**

Customer:

DRW:	Dong	CHKD	Chang	MATL:	Chui	DATE	07.12.2009
APPD:	Ping			FINISH	Hui	Sheet	3 from 6

Copyright by EDCON-COMPONENTS



**Typical Characteristics**

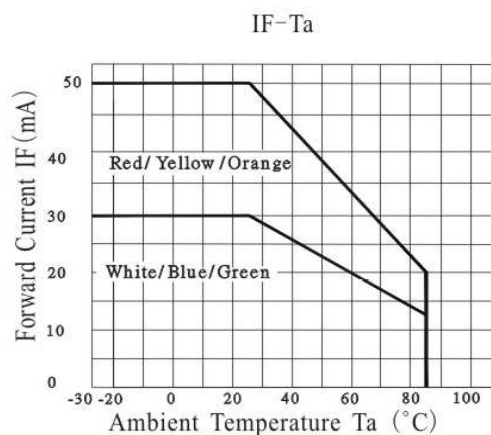
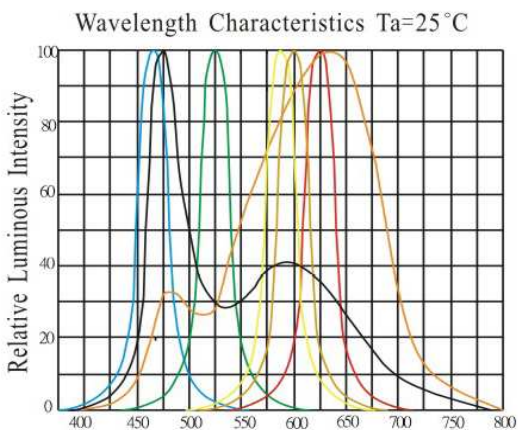
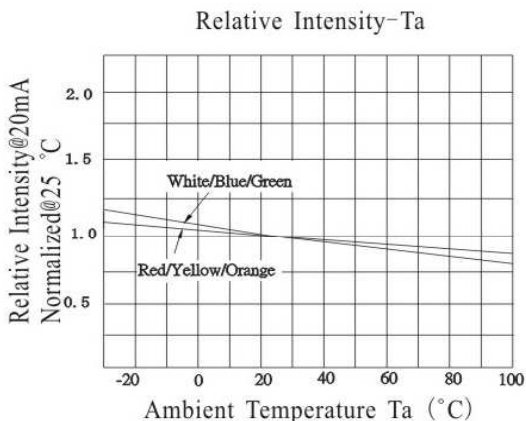
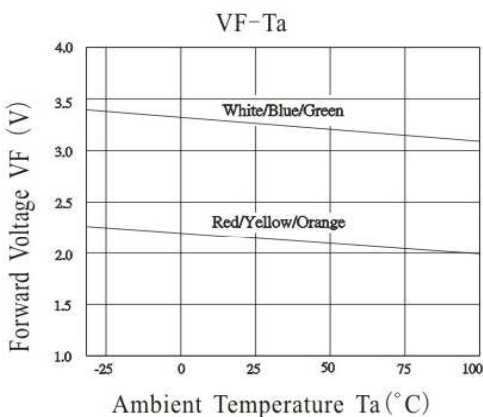
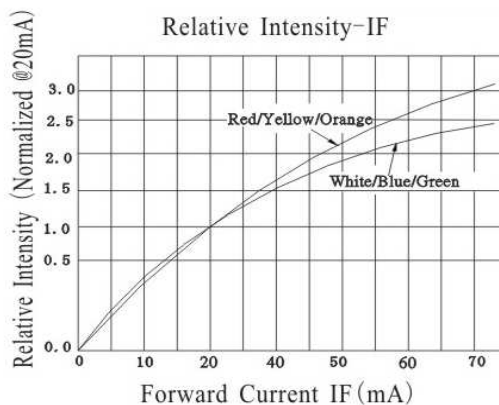
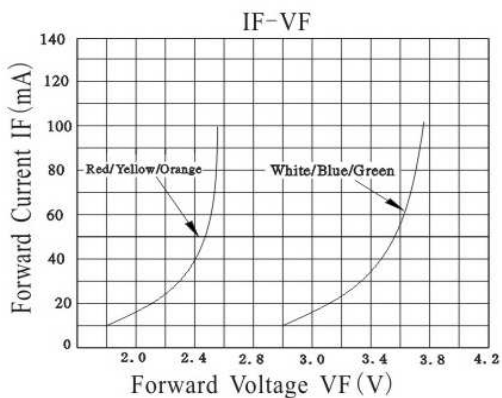

**Super Flux  
 Pure White**

Part No.: **M13J9013**

Customer:

DRW:	Dong	CHKD	Chang	MATL:	Chui	DATE	07.12.2009
APPD:	Ping			FINISH	Hui	Sheet	4 from 6



**Solder Condition**

**Lead Free Solder**

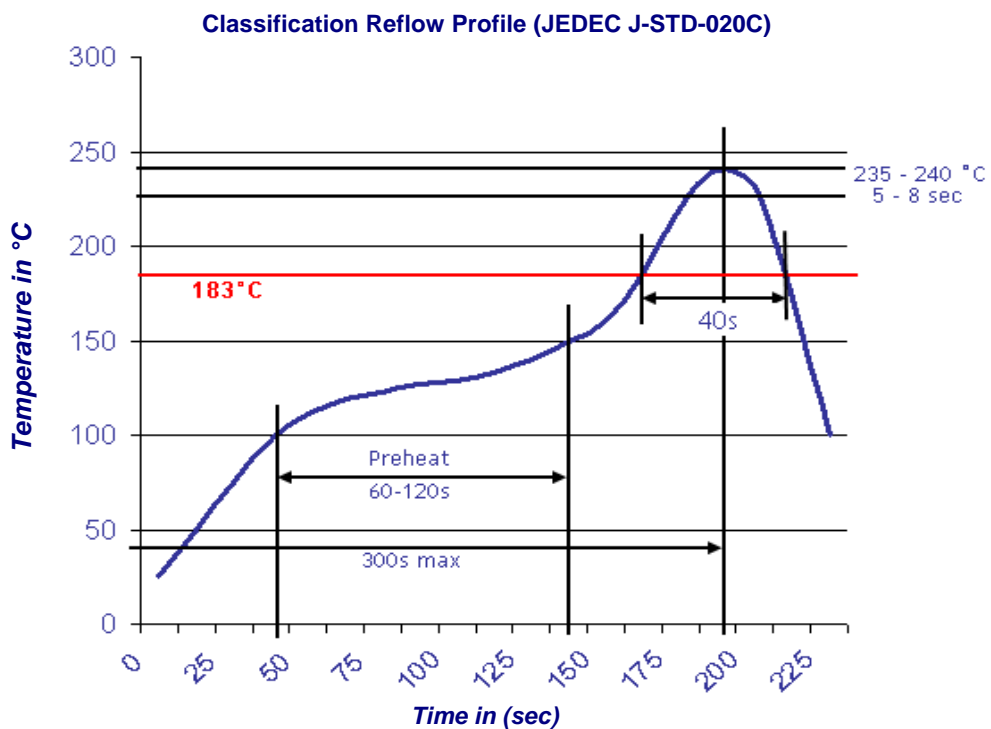

<b>Super Flux Pure White</b>	
Part No.:	<b>M13J9013</b>
Customer:	

DRW:	Dong	CHKD	Chang	MATL:	Chui	DATE	07.12.2009
APPD:	Ping			FINISH	Hui	Sheet	5 from 6



**Color table curve**

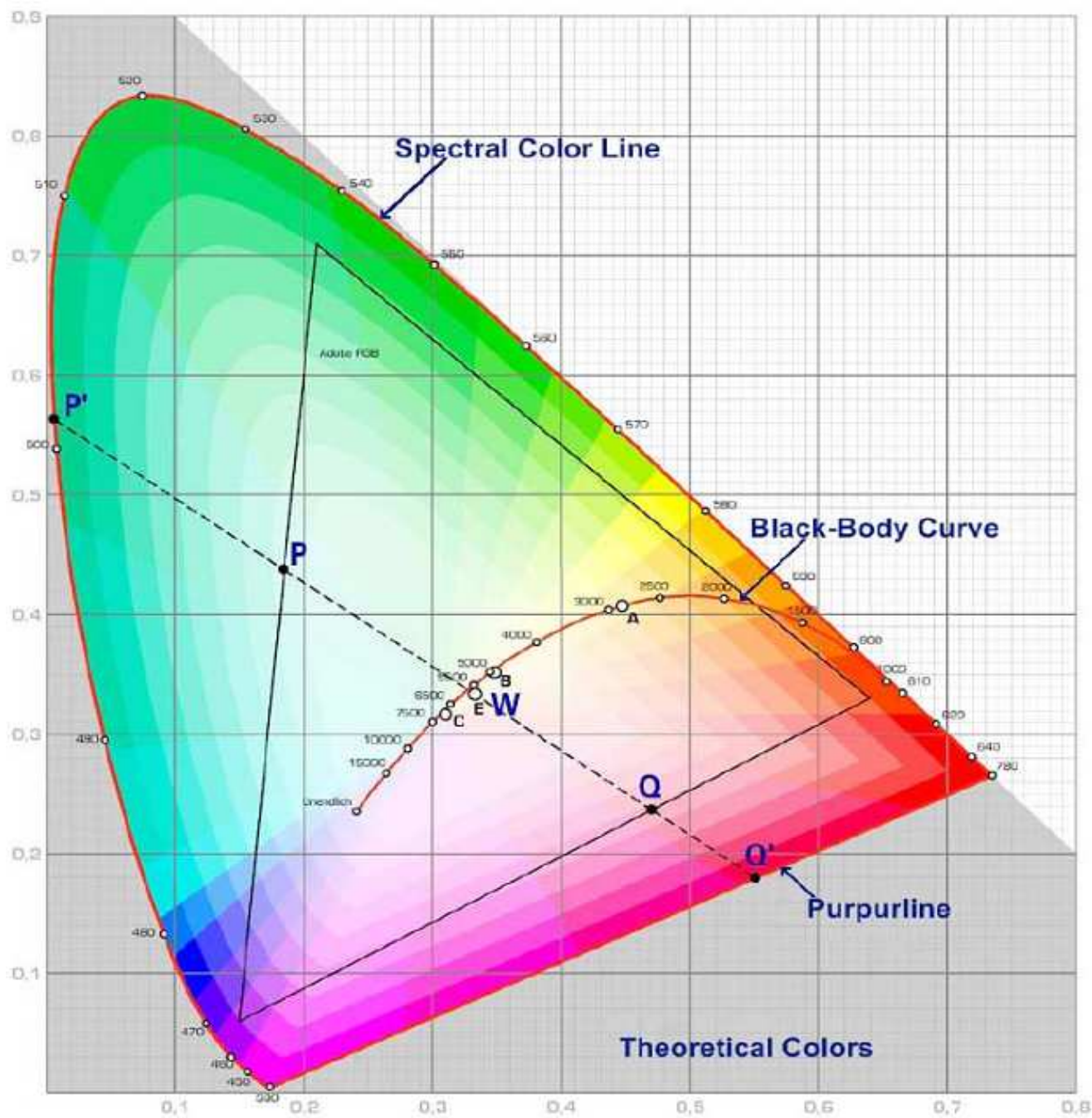

<b>Super Flux Pure White</b>	
Part No.:	<b>M13J9013</b>
Customer:	

DRW:	Dong	CHKD	Chang	MATL:	Chui	DATE	07.12.2009
APPD:	Ping			FINISH	Hui	Sheet	6 from 6

Copyright by EDCON-COMPONENTS