

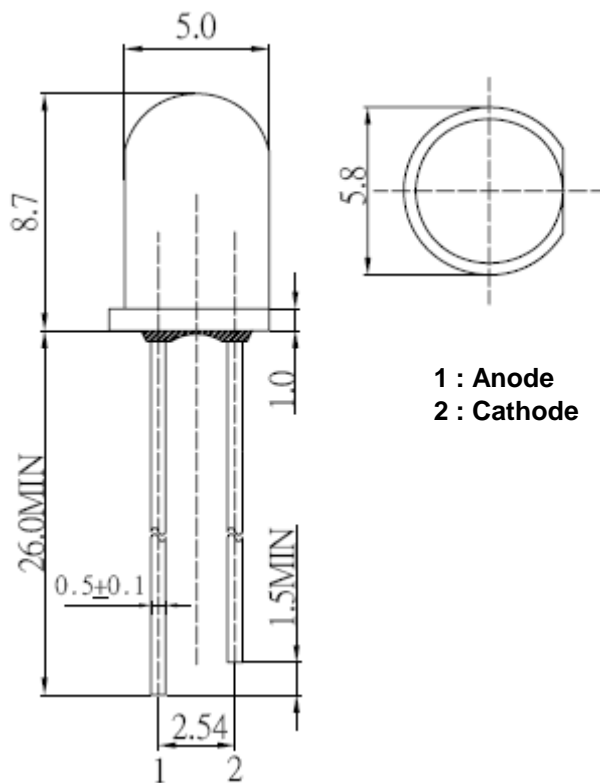

Applications

- Electronic Signs and Signals
- Small Area Illuminations
 - Back Lighting
 - Other Lighting

Technical Drawing



1 : Anode
 2 : Cathode

Notes :

All dimensions in mm tolerance is ± 0.1 mm unless otherwise noted.

Round Blinking LED		
Red	Blue	Green
Part No.:		M13J6002
Customer:		

DRW:	Ron	CHKD	Lang	MATL:	Chang	DATE	05.12.2009
APPD:	Xie			FINISH	Wang	Sheet	1 from 6



Absolute Maximum Ratings

Ta=25°C

Item	Symbol	---	---	Unit
Power Dissipation	P _D		---	mW
DC Forward Current	I _F		---	mA
Plused Forward Current	I _{FP} *		---	mA
Reverse Voltage	V _R		5	V
Operating Temperature	T _{OP}		-30 to 85	°C
Storage Temperature	T _{ST}		-40 to 100	°C
Derating Linear From 50°C	---		---	mA / °C

* 0.1 msec pulse, 10% duty cycle

Electrcal / Optical Characteristics

I_F=20mA Ta=25°C

Ermitting Color	Red		Blue	Green	
Material	---		---	---	
Forward Voltage	typ.	4.5	4.5	4.5	V _F
	max.	5.0	5.0	5.0	V _F
Wavelength typ.	λ _D	620	465	520	nm
	λ _P	625	470	525	nm
	Δλ	---	---	---	nm
Oscillator Frequency	min.	---	---	---	Hz
	typ.	33	33	33	Hz
	max.	---	---	---	Hz
Duty Cycle	typ.	---	---	---	---
Luminous Intensity *	min.	3000	1560	5800	mcd
	typ.	4000	2180	7000	mcd
Reverse Current	max.		---		μA
Viewing Angle	2Θ1/2		30		

Round Blinking LED		
Red	Blue	Green
Part No.:		M13J6002
Customer:		

DRW:	Ron	CHKD	Lang	MATL:	Chang	DATE	05.12.2009
APPD:	Xie			FINISH	Wang	Sheet	2 from 6



Directive Characteristics

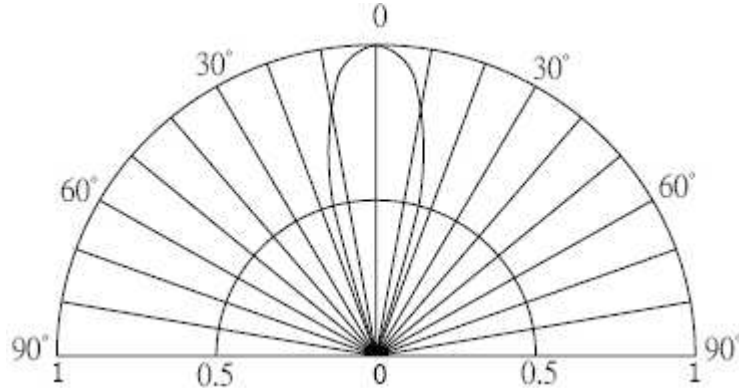

Round Blinking LED			
Red	Blue	Green	
Part No.:		M13J6002	
Customer:			

DRW:	Ron	CHKD	Lang	MATL:	Chang	DATE	05.12.2009
APPD:	Xie			FINISH	Wang	Sheet	3 from 6



Typical Characteristics

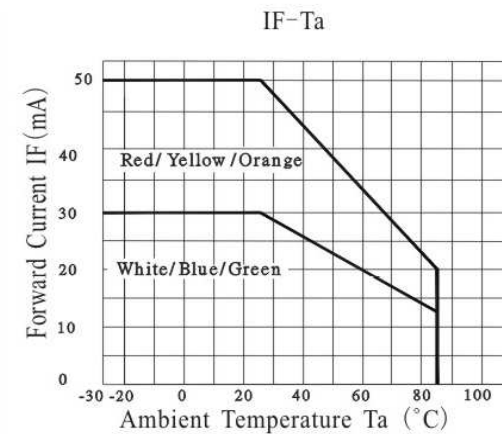
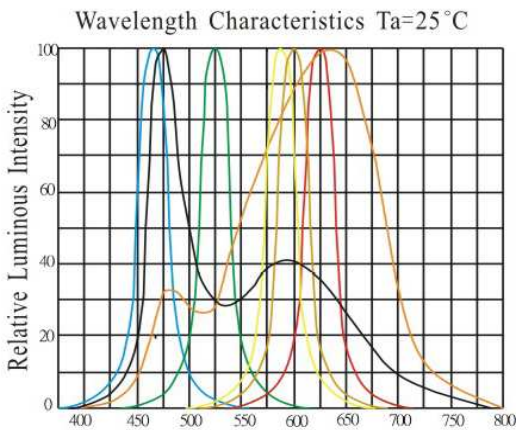
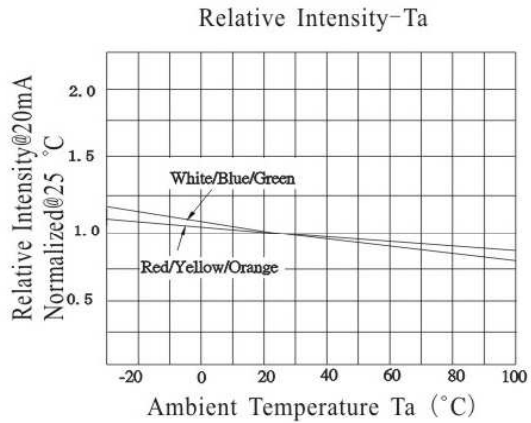
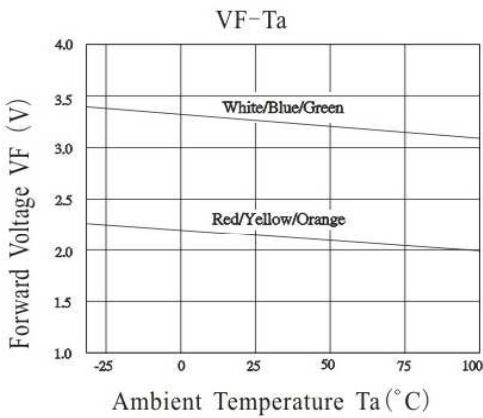
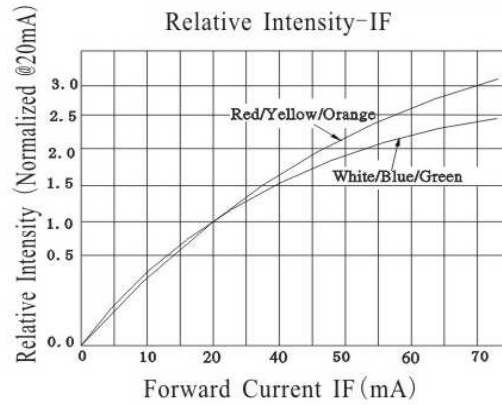
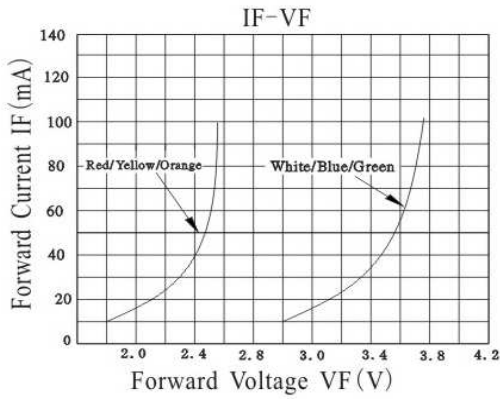

Round Blinking LED			
Red	Blue	Green	
Part No.:			M13J6002
Customer:			

DRW:	Ron	CHKD	Lang	MATL:	Chang	DATE	05.12.2009
APPD:	Xie			FINISH	Wang	Sheet	4 from 6



Solder Condition

Lead Free Solder

Classification Reflow Profile (JEDEC J-STD-020C)

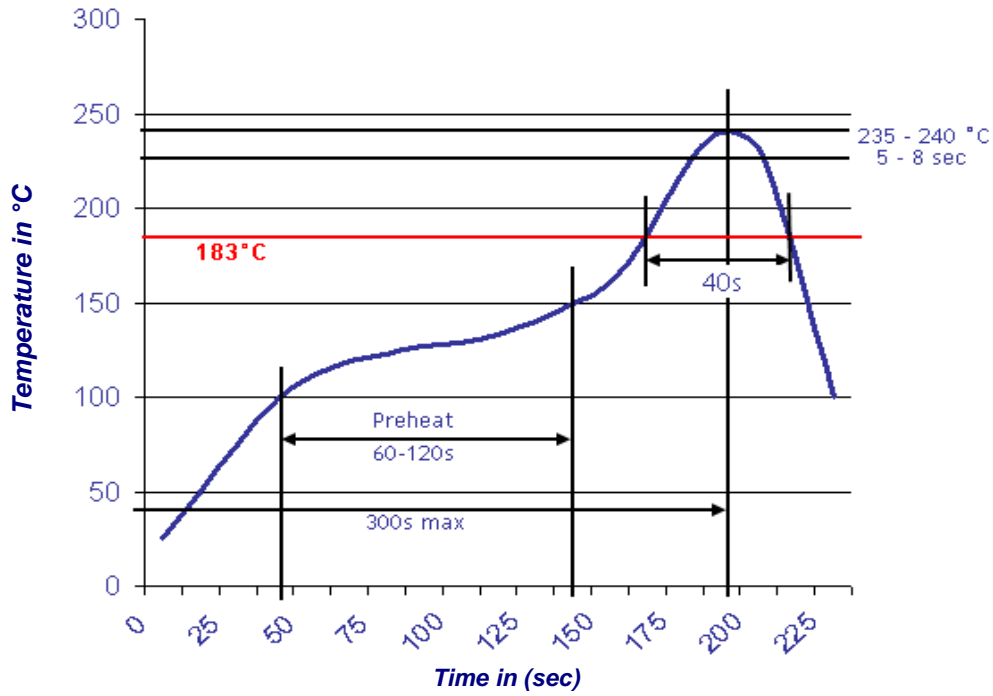

Round Blinking LED	
Red	Blue
Green	
Part No.:	M13J6002
Customer:	

DRW:	Ron	CHKD	Lang	MATL:	Chang	DATE	05.12.2009
APPD:	Xie			FINISH	Wang	Sheet	5 from 6



Color table curve

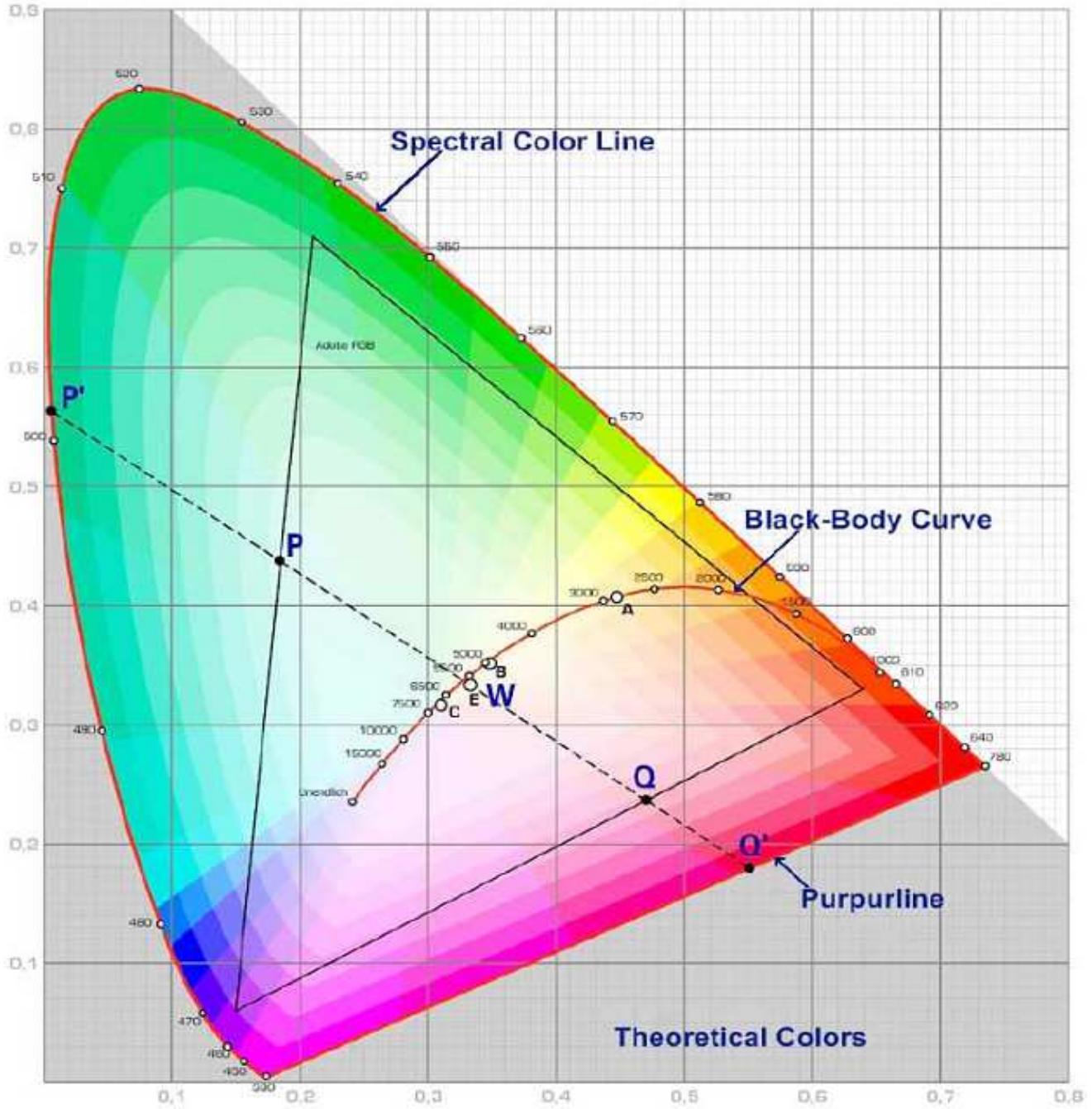

Round Blinking LED		
Red	Blue	Green
Part No.:		M13J6002
Customer:		

DRW:	Ron	CHKD	Lang	MATL:	Chang	DATE	05.12.2009
APPD:	Xie			FINISH	Wang	Sheet	6 from 6