

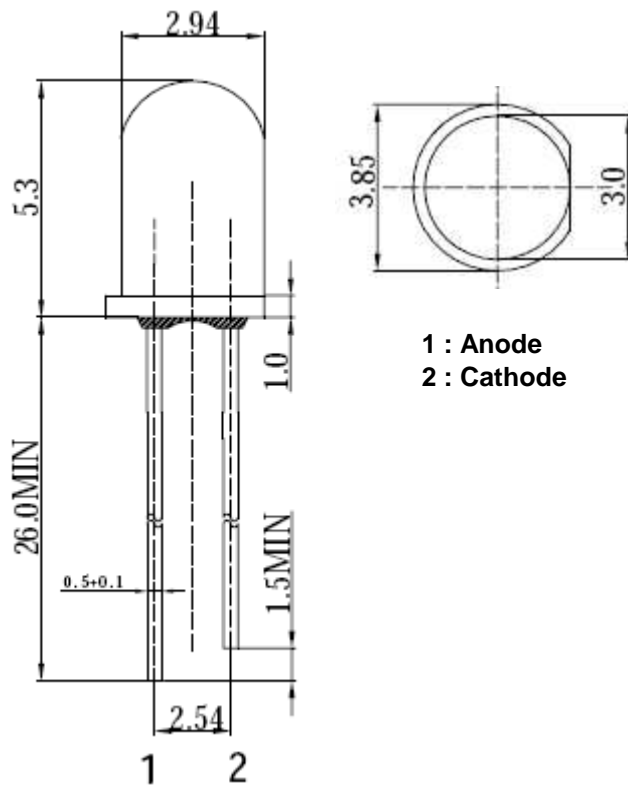

**Applications**

- Electronic Signs and Signals
- Small Area Illuminations
- Back Lighting
- Other Lighting

**Technical Drawing**



1 : Anode  
 2 : Cathode

**Notes :**

All dimensions in mm tolerance is  $\pm 0.1$ mm unless otherwise noted.

<b>Blinking Round LED</b>	
<b>Orange</b>	
Part No.:	<b>M13J3012</b>
Customer:	

DRW:	Dong	CHKD	Chang	MATL:	Chui	DATE	24.06.2010
APPD:	Ping			FINISH	Hui	Sheet	1 from 6



**Absolute Maximum Ratings**

Ta=25°C

Item	Symbol	---	Unit
Power Dissipation	P <sub>D</sub>	---	mW
DC Forward Current	I <sub>F</sub>	---	mA
Pulsed Forward Current	I <sub>FP</sub> *	---	mA
Reverse Voltage	V <sub>R</sub>	5	V
Operating Temperature	T <sub>OP</sub>	-30 to 85	°C
Storage Temperature	T <sub>ST</sub>	-40 to 100	°C

\* 0.1 msec pulse, 10% duty cycle

**Electrical / Optical Characteristics**

I<sub>F</sub>=20mA Ta=25°C

Ermitting Color	Orange		
Material	---		
Forward Voltage	typ.	3.3	V <sub>F</sub>
	max.	5.0	V <sub>F</sub>
Wavelength typ.	λ <sub>D</sub>	600	nm
	λ <sub>P</sub>	605	nm
	Δλ	---	nm
Oscillator Frequency	F <sub>led</sub>	1.8	Hz
Duty Cycle	Duty	1/2	---
Luminous Intensity *	min.	1560	mcd
	typ.	2000	mcd
Reverse Current	max.	---	μA
Viewing Angle	2θ <sub>1/2</sub>	30	

\* Per NIST standards

**Blinking Round LED  
Orange**

Part No.: **M13J3012**

Customer:

DRW:	Dong	CHKD	Chang	MATL:	Chui	DATE	24.06.2010
APPD:	Ping			FINISH	Hui	Sheet	2 from 6



**Directive Characteristics**

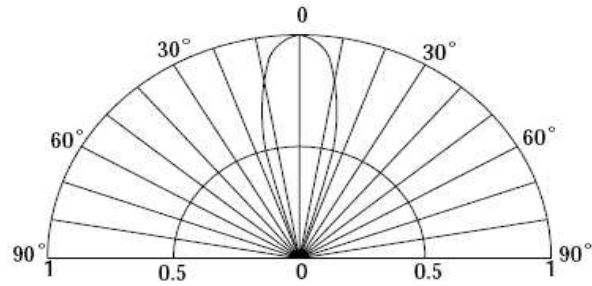

**Blinking Round LED  
Orange**

Part No.: **M13J3012**

Customer:

DRW:	Dong	CHKD	Chang	MATL:	Chui	DATE	24.06.2010
APPD:	Ping			FINISH	Hui	Sheet	3 from 6



**Typical Characteristics**

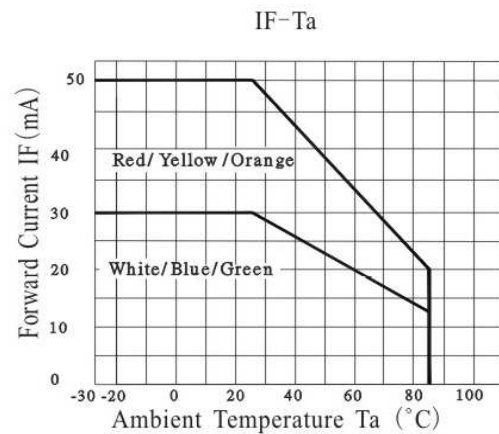
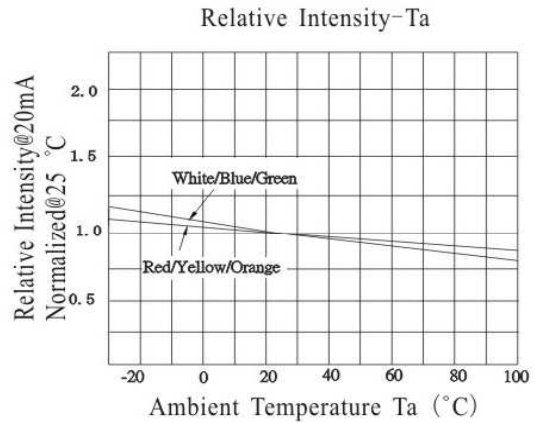
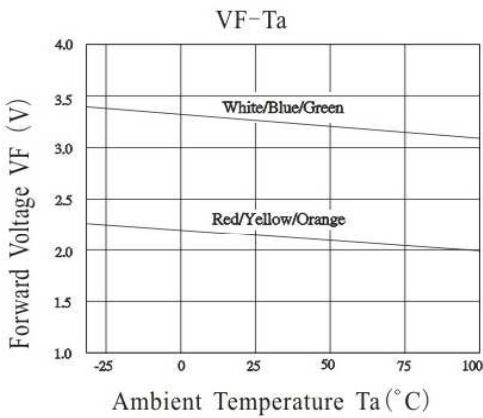
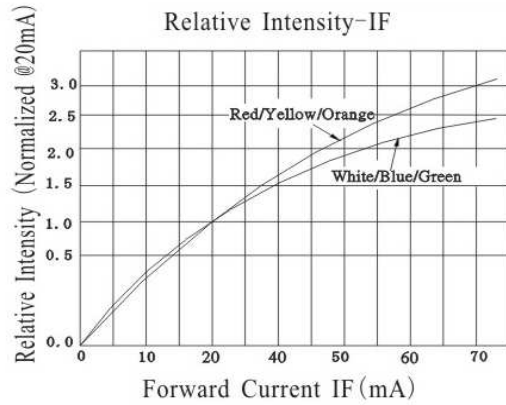
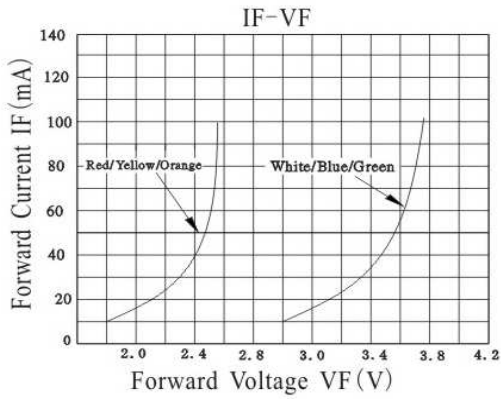

**Blinking Round LED  
 Orange**

Part No.: **M13J3012**

Customer:

DRW:	Dong	CHKD	Chang	MATL:	Chui	DATE	24.06.2010
APPD:	Ping			FINISH	Hui	Sheet	4 from 6



**Solder Condition**

**Lead Free Solder**



<b>Blinking Round LED Orange</b>	
Part No.:	<b>M13J3012</b>
Customer:	

DRW:	Dong	CHKD	Chang	MATL:	Chui	DATE	24.06.2010
APPD:	Ping			FINISH	Hui	Sheet	5 from 6



**Color table curve**

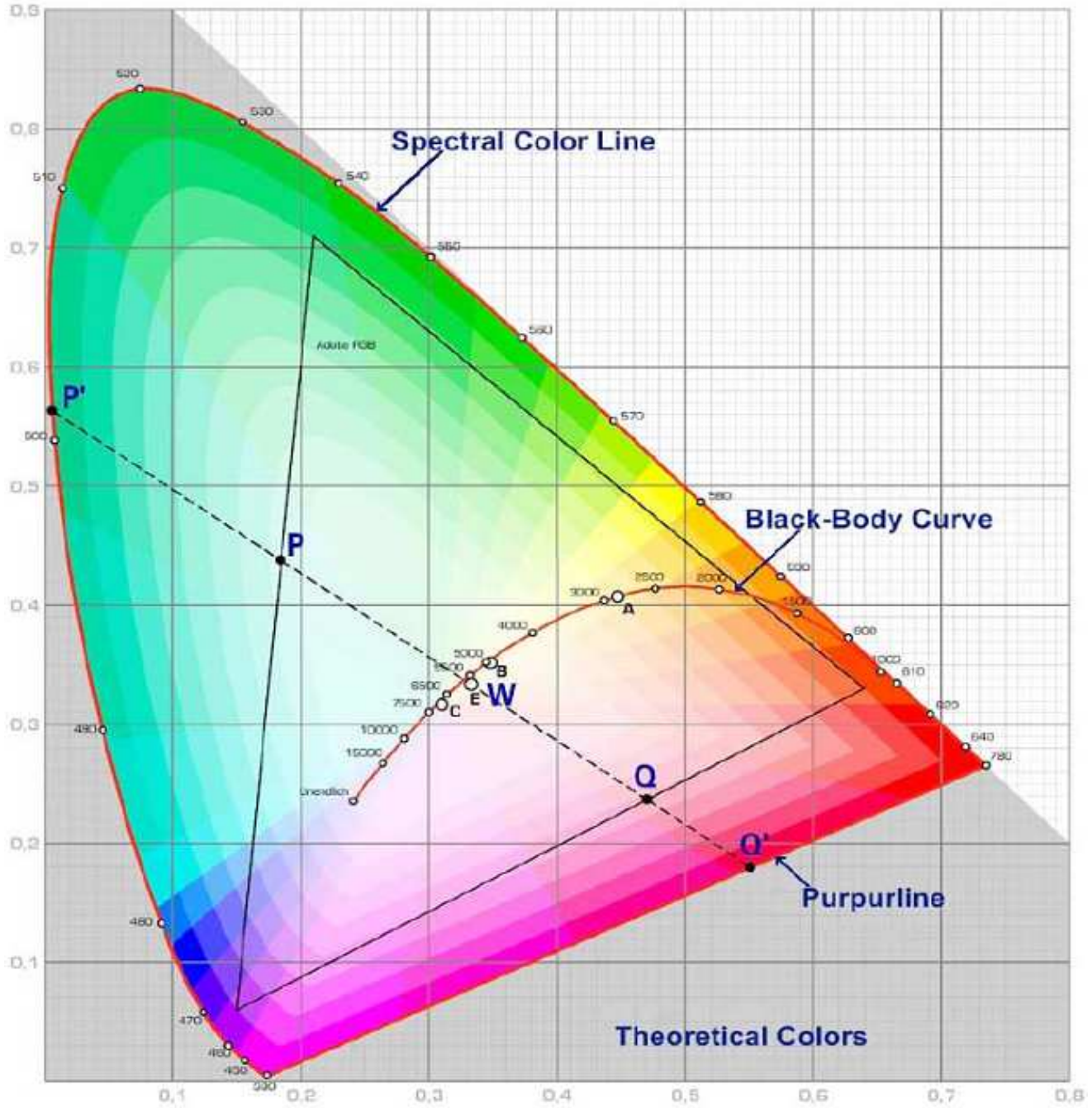

<b>Blinking Round LED Orange</b>	
Part No.:	<b>M13J3012</b>
Customer:	

DRW:	Dong	CHKD	Chang	MATL:	Chui	DATE	24.06.2010
APPD:	Ping			FINISH	Hui	Sheet	6 from 6

Copyright by EDCON-COMPONENTS