

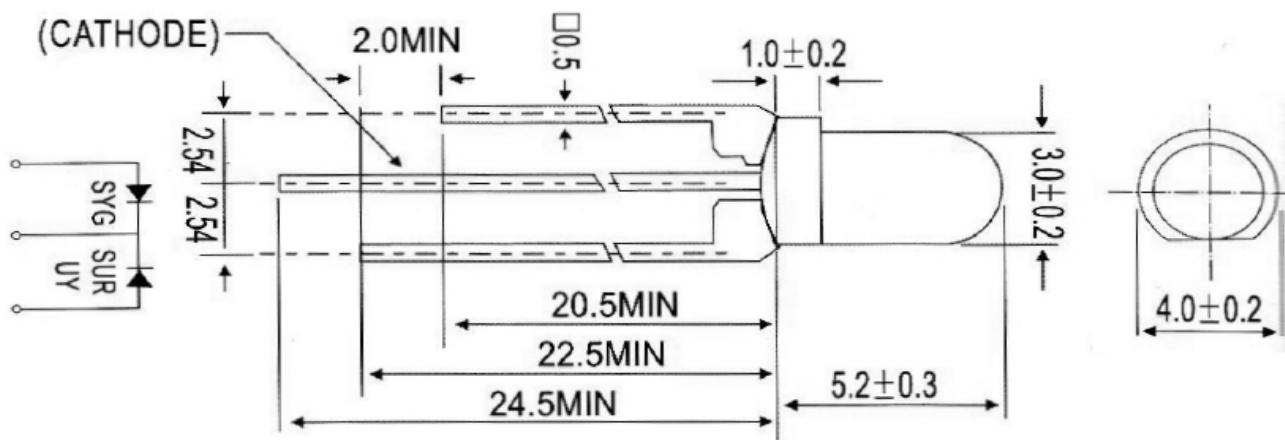

Applications

- Electronic Signs and Signals
- Small Area Illuminations
 - Back Lighting
 - Other Lighting

Technical Drawing



Notes :

All dimensions in mm tolerance is ± 0.1mm unless otherwise noted.

Round LED	
Yellow	Yellow Green
Part No.:	M13G9009
Customer:	

DRW:	Ron	CHKD	Lang	MATL:	Chang	DATE	01.07.2010
APPD:	Xie			FINISH	Wang	Sheet	1 from 6



Absolute Maximum Ratings

Item	Symbol	---	---	Unit
Power Dissipation	P_D		78	mW
DC Forward Current	I_F		30	mA
Pulsed Forward Current	I_{FP}^*		100	mA
Reverse Voltage	V_R		5	V
Operating Temperature	T_{OP}		-30 to 85	°C
Storage Temperature	T_{ST}		-40 to 100	°C

* 0.1 msec pulse, 10% duty cycle

Electrical / Optical Characteristics

Emitting Color	Yellow		Yellow Green	
	---		---	
Material	---		---	
Forward Voltage	typ.	2.1	2.1	V_F
	max.	2.6	2.6	V_F
Wavelength typ.	λ_D	585	565	nm
	λ_P	590	570	nm
	$\Delta\lambda$	---	---	nm
Color Temperature	min.	---	---	K
	max.	---	---	K
Luminous Intensity *	min.	330	330	mcd
	typ.	550	400	mcd
Reverse Current	max.	10		μA
Viewing Angle	$2\Theta_{1/2}$	30		

* Per NIST standards

Round LED	
Yellow	Yellow Green
Part No.:	M13G9009
Customer:	

DRW:	Ron	CHKD	Lang	MATL:	Chang	DATE	01.07.2010
APPD:	Xie			FINISH	Wang	Sheet	2 from 6



Directive Characteristics

Round LED Yellow Yellow Green	
Part No.:	M13G9009
Customer:	

DRW:	Ron	CHKD	Lang	MATL:	Chang	DATE	01.07.2010
APPD:	Xie			FINISH	Wang	Sheet	3 from 6



Typical Characteristics

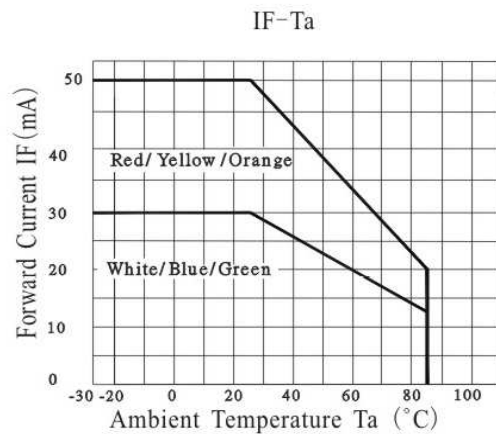
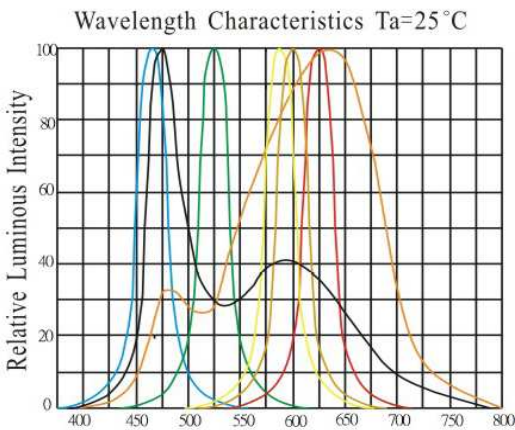
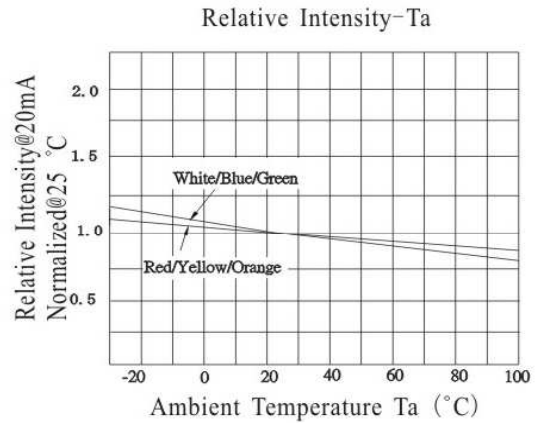
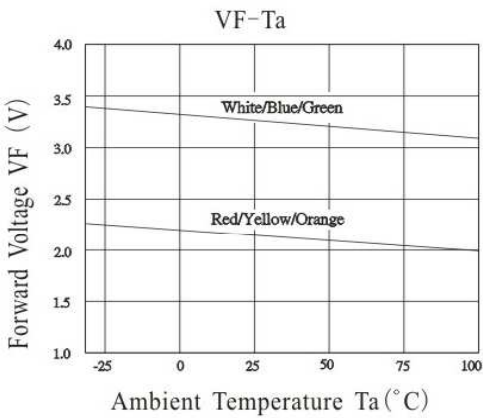
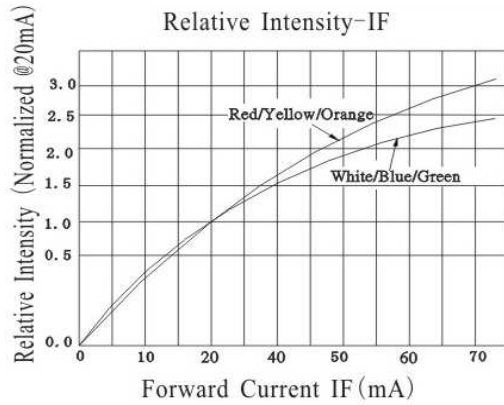
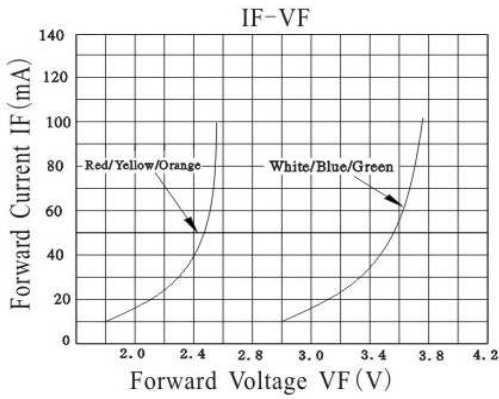

Round LED	
Yellow	Yellow Green
Part No.:	M13G9009
Customer:	

DRW:	Ron	CHKD	Lang	MATL:	Chang	DATE	01.07.2010
APPD:	Xie			FINISH	Wang	Sheet	4 from 6



Solder Condition

Lead Free Solder

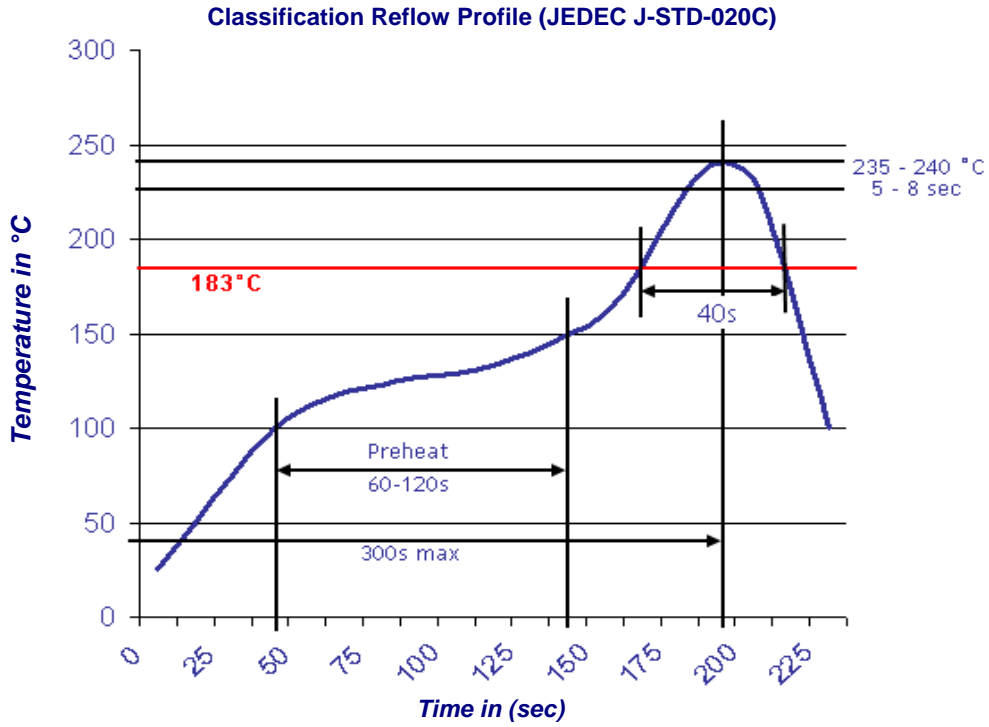

Round LED	
Yellow	Yellow Green
Part No.:	M13G9009
Customer:	

DRW:	Ron	CHKD	Lang	MATL:	Chang	DATE	01.07.2010
APPD:	Xie			FINISH	Wang	Sheet	5 from 6



Color table curve

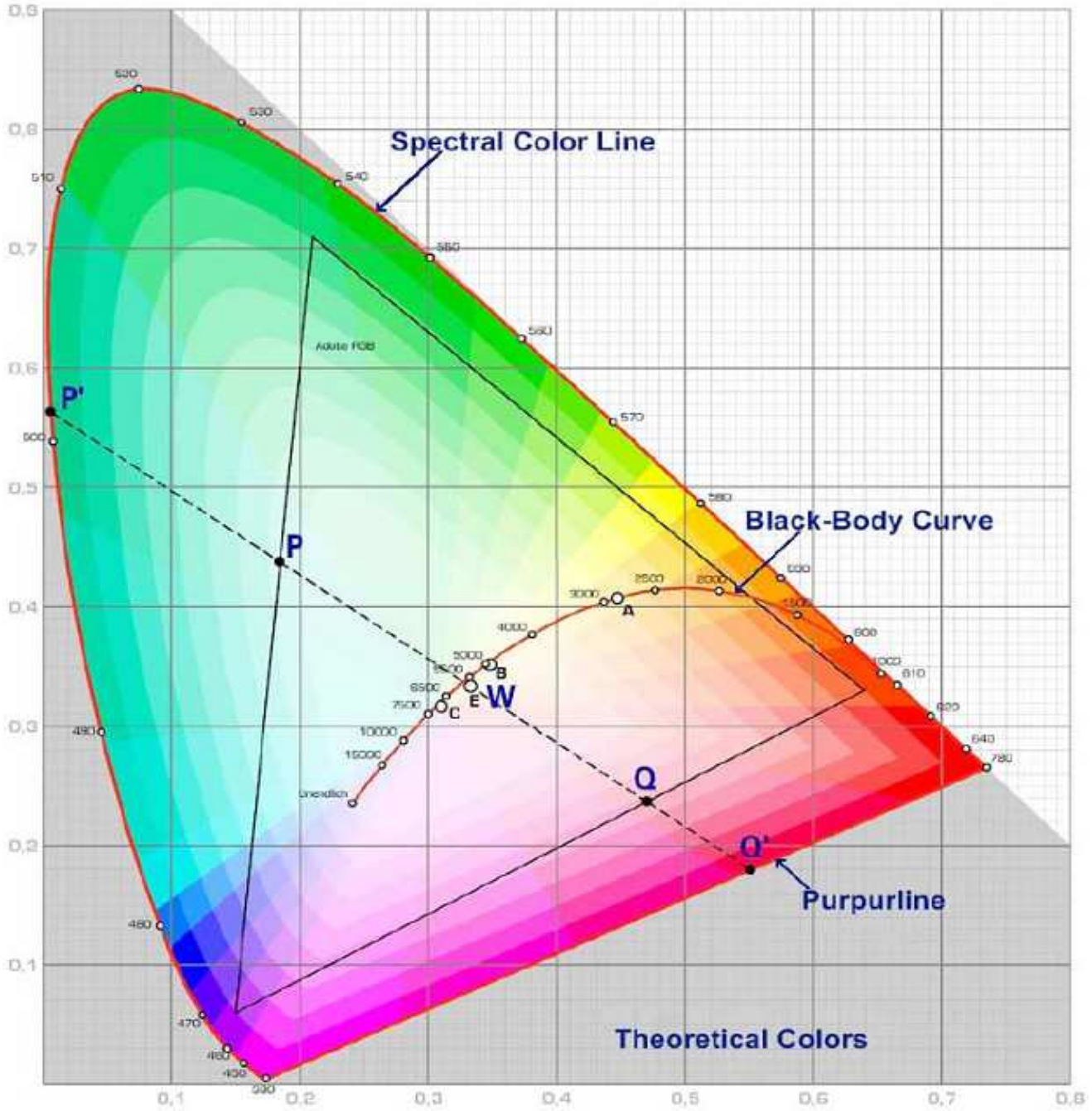

Round LED	
Yellow	Yellow Green
Part No.:	M13G9009
Customer:	

DRW:	Ron	CHKD	Lang	MATL:	Chang	DATE	01.07.2010
APPD:	Xie			FINISH	Wang	Sheet	6 from 6