

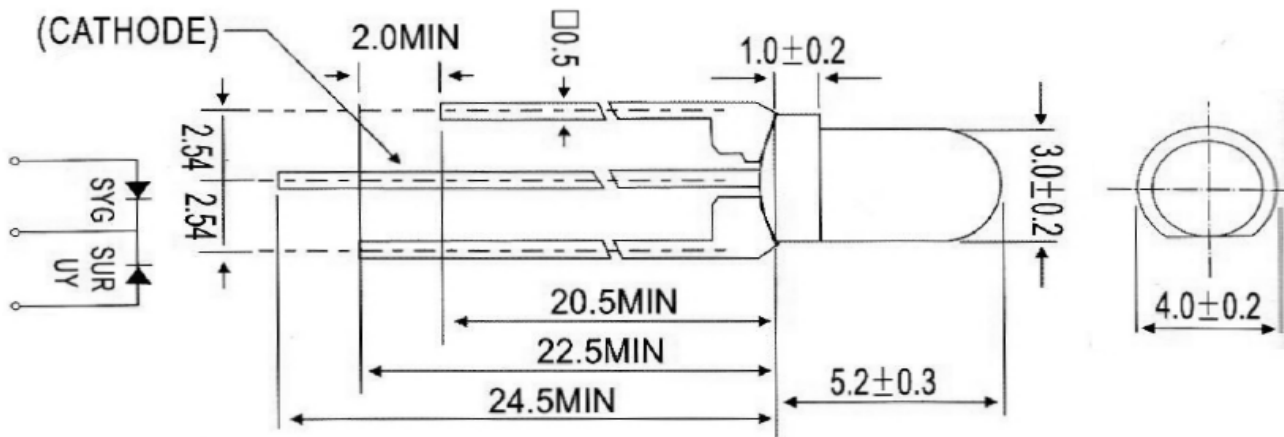

Applications

- Electronic Signs and Signals
- Small Area Illuminations
 - Back Lighting
 - Other Lighting

Technical Drawing



Notes :

All dimensions in mm tolerance is ± 0.1mm unless otherwise noted.

Round LED	
Red	Blue
Part No.:	M13G9008
Customer:	

DRW:	Ron	CHKD	Lang	MATL:	Chang	DATE	01.07.2010
APPD:	Xie			FINISH	Wang	Sheet	1 from 6



Absolute Maximum Ratings

Item	Symbol	---	---	Unit
Power Dissipation	P _D	78	108	mW
DC Forward Current	I _F	30		mA
Pulsed Forward Current	I _{FP} *	100		mA
Reverse Voltage	V _R	5		V
Operating Temperature	T _{OP}	-30 to 85		°C
Storage Temperature	T _{ST}	-40 to 100		°C

* 0.1 msec pulse, 10% duty cycle

Electrical / Optical Characteristics

Ermitting Color	Red		Blue	
Material	---		---	
Forward Voltage	typ.	2.1	3.1	V _F
	max.	2.6	3.6	V _F
Wavelength typ.	λ _D	620	465	nm
	λ _P	625	470	nm
	Δλ	---	---	nm
Color Temperature	min.	---	---	K
	max.	---	---	K
Luminous Intensity *	min.	2180	1200	mcd
	typ.	3300	1560	mcd
Reverse Current	max.	10		μA
Viewing Angle	2Θ1/2	30		

* Per NIST standards

Round LED	
Red	Blue
Part No.:	M13G9008
Customer:	

DRW:	Ron	CHKD	Lang	MATL:	Chang	DATE	01.07.2010
APPD:	Xie			FINISH	Wang	Sheet	2 from 6



Directive Characteristics

Round LED	
<i>Red</i>	<i>Blue</i>
Part No.:	M13G9008
Customer:	

DRW:	Ron	CHKD	Lang	MATL:	Chang	DATE	01.07.2010
APPD:	Xie			FINISH	Wang	Sheet	3 from 6



Typical Characteristics

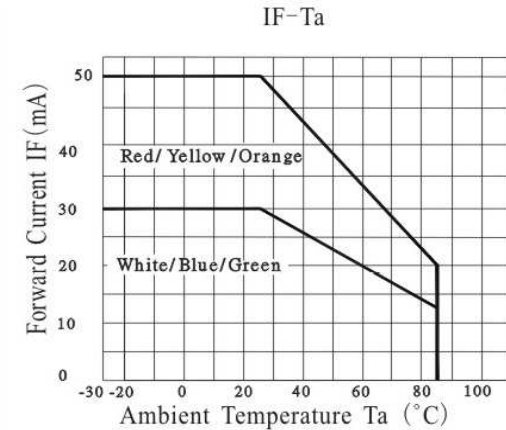
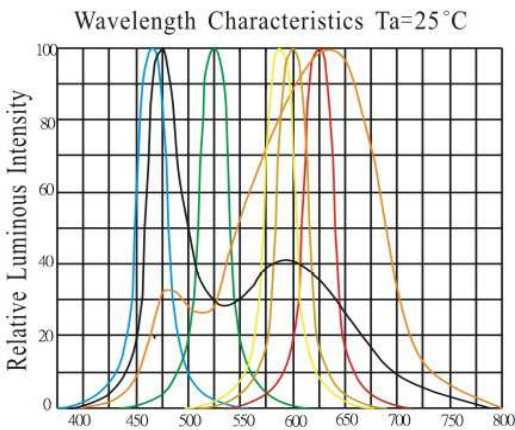
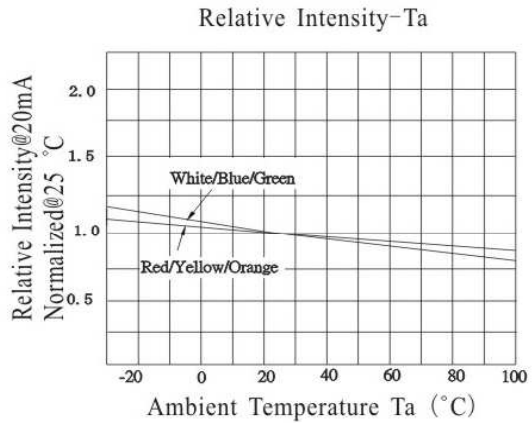
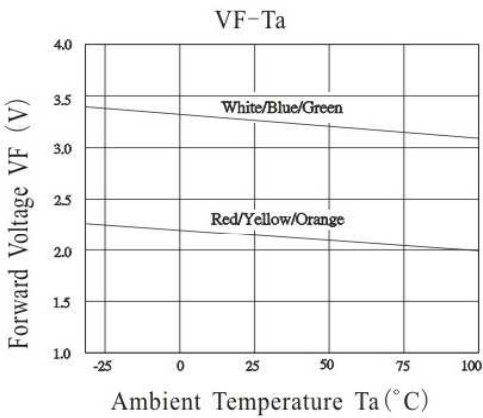
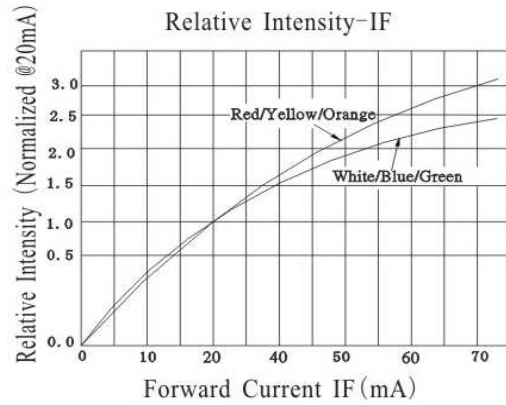
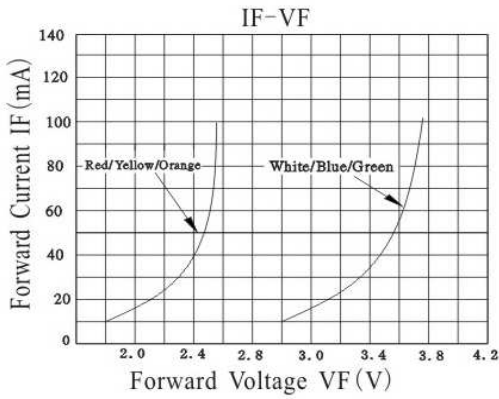

Round LED	
Red	Blue
Part No.:	M13G9008
Customer:	

DRW:	Ron	CHKD	Lang	MATL:	Chang	DATE	01.07.2010
APPD:	Xie			FINISH	Wang	Sheet	4 from 6



Solder Condition

Lead Free Solder

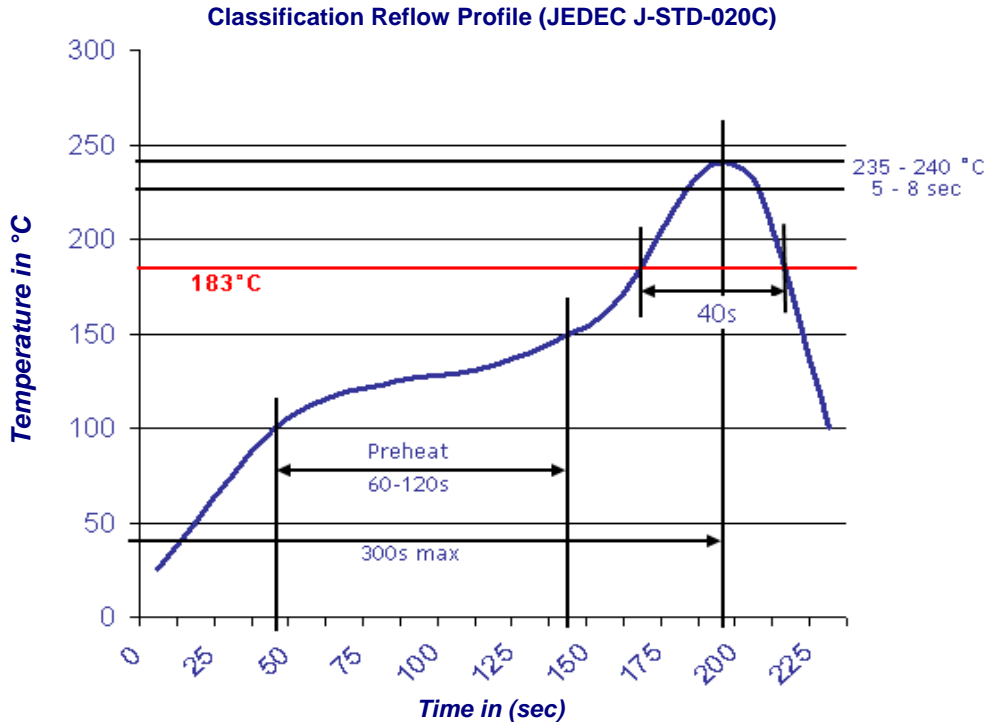

Round LED	
Red	Blue
Part No.:	M13G9008
Customer:	

DRW:	Ron	CHKD	Lang	MATL:	Chang	DATE	01.07.2010
APPD:	Xie			FINISH	Wang	Sheet	5 from 6



Color table curve

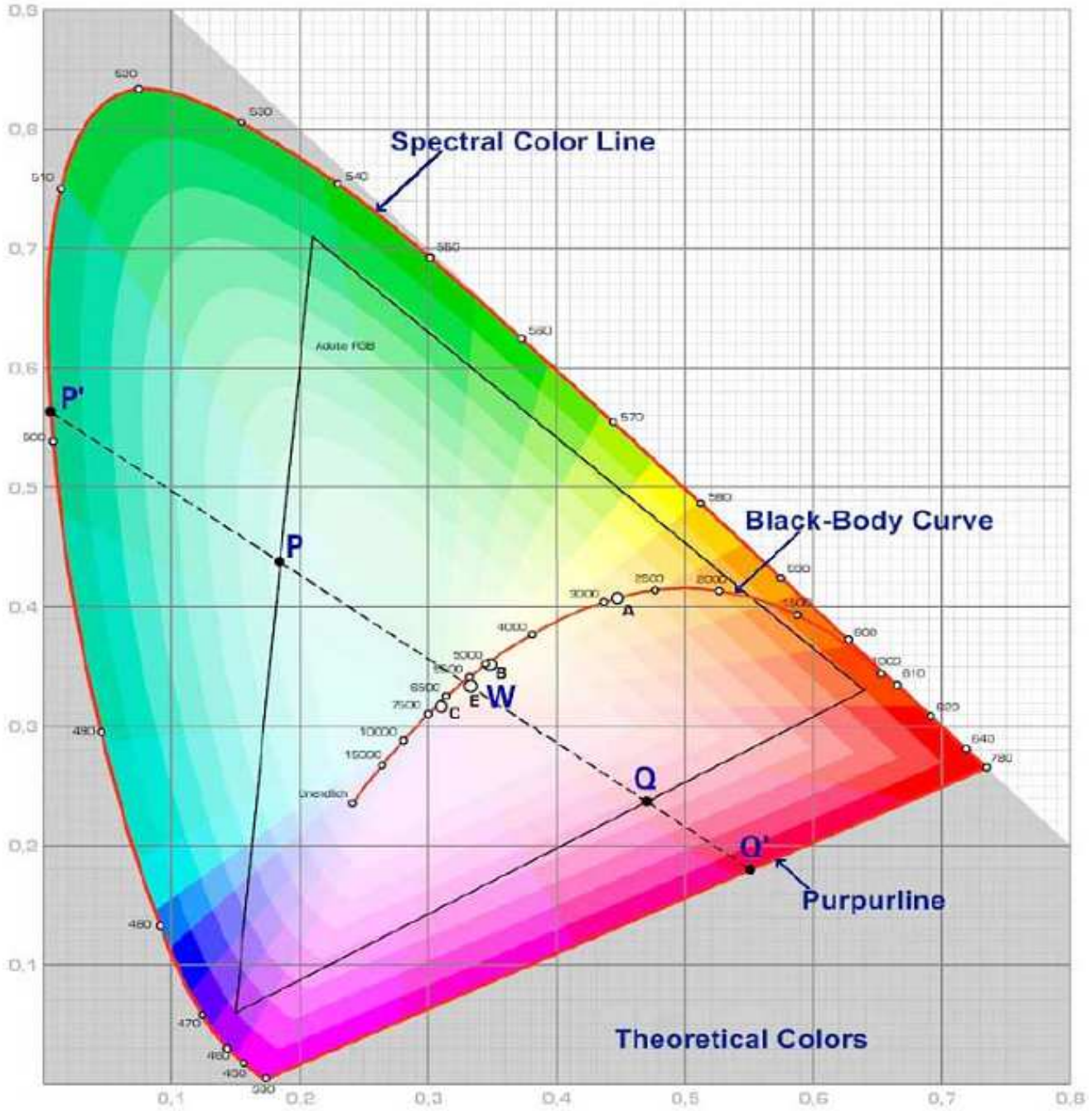

Round LED	
<i>Red</i>	<i>Blue</i>
Part No.:	M13G9008
Customer:	

DRW:	Ron	CHKD	Lang	MATL:	Chang	DATE	01.07.2010
APPD:	Xie			FINISH	Wang	Sheet	6 from 6