

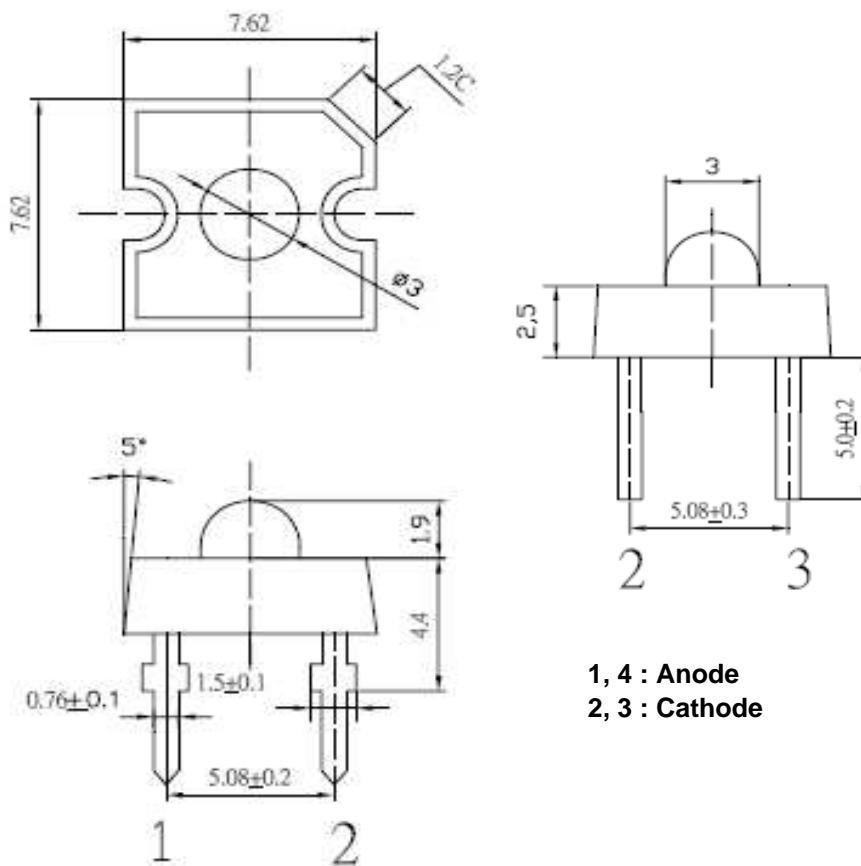

Applications

- Electronic Signs and Signals
- Small Area Illuminations
 - Back Lighting
 - Other Lighting

Technical Drawing



1, 4 : Anode
 2, 3 : Cathode

Notes :

All dimensions in mm tolerance is ± 0.1 mm unless otherwise noted.

Super Flux Warm White	
Part No.:	M13G1002
Customer:	

DRW:	Dong	CHKD	Chang	MATL:	Chui	DATE	22.10.2010
APPD:	Ping			FINISH	Hui	Sheet	1 from 6



Absolute Maximum Ratings

Item	Symbol	---	Unit
Power Dissipation	P _D	180	mW
DC Forward Current	I _F	50	mA
Pulsed Forward Current	I _{FP} *	100	mA
Reverse Voltage	V _R	5	V
Operating Temperature	T _{OP}	-30 to 85	°C
Storage Temperature	T _{ST}	-40 to 100	°C

* 0.1 msec pulse, 10% duty cycle

Electrical / Optical Characteristics

Ermitting Color	Warm White		
Material	---		
Forward Voltage	typ.	3.1	V _F
	max.	3.6	V _F
Wavelength typ.	λ _D	x = 0.41 y = 0.37	nm
	λ _P	---	nm
	Δλ	---	nm
Color Temperature	min.	---	K
	max.	---	K
Luminous Intensity *	min.	5800	mcd
	typ.	7000	mcd
Reverse Current	max.	10	μA
Viewing Angle	2θ1/2	60	

* Per NIST standards

**Super Flux
Warm White**

Part No.: **M13G1001**

Customer:

DRW:	Dong	CHKD	Chang	MATL:	Chui	DATE	22.10.2010
APPD:	Ping			FINISH	Hui	Sheet	2 from 6



Directive Characteristics

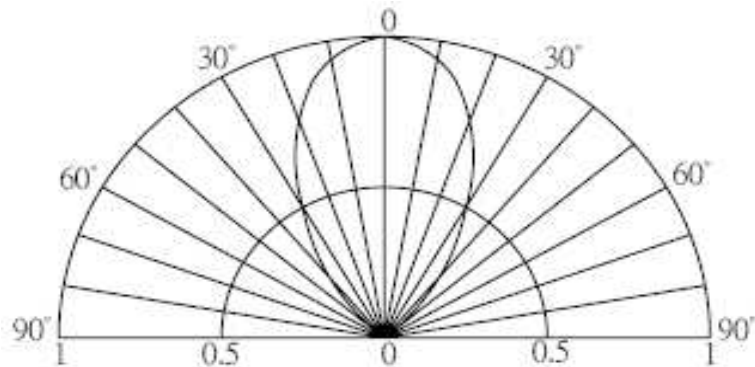

**Super Flux
Warm White**

Part No.: **M13G1002**

Customer:

DRW:	Dong	CHKD	Chang	MATL:	Chui	DATE	22.10.2010
APPD:	Ping			FINISH	Hui	Sheet	3 from 6



Typical Characteristics

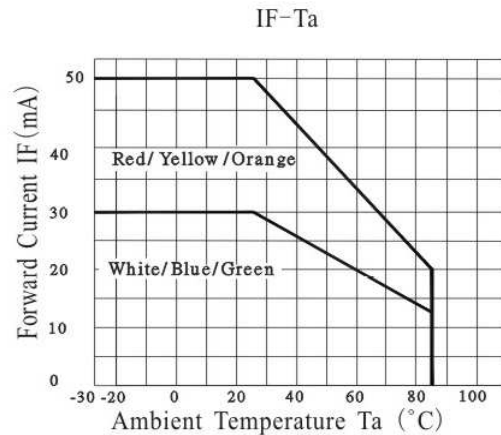
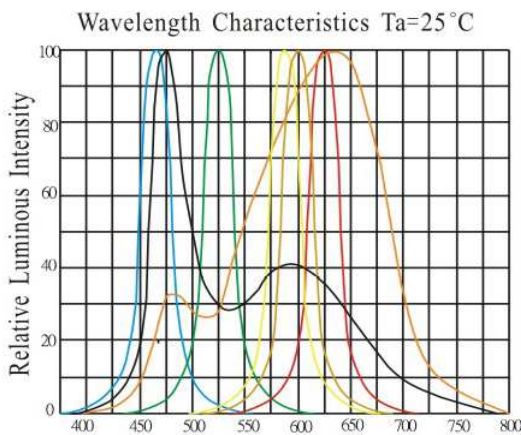
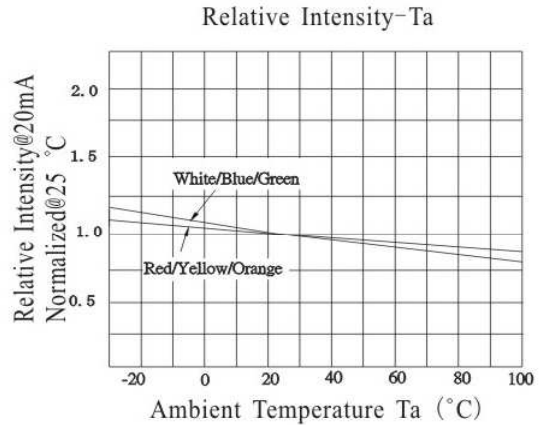
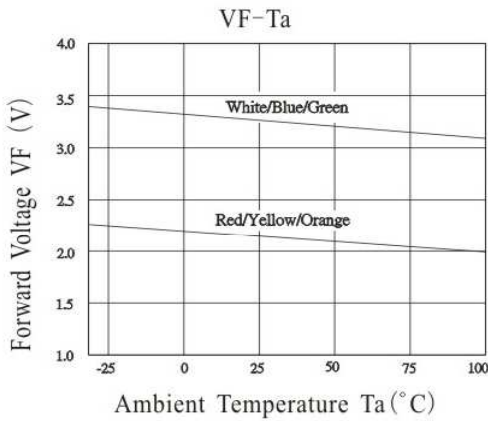
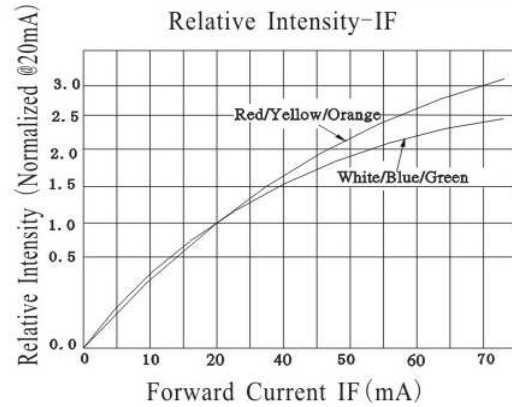
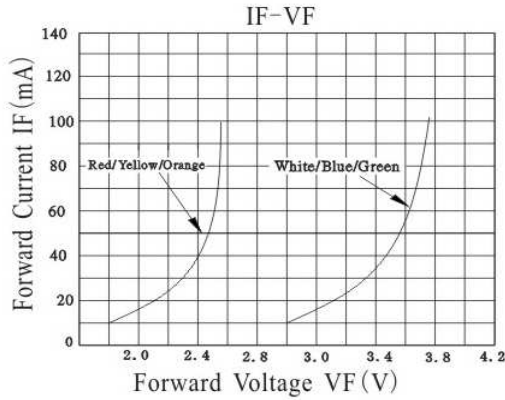

Super Flux Warm White	
Part No.:	M13G1002
Customer:	

DRW:	Dong	CHKD	Chang	MATL:	Chui	DATE	22.10.2010
APPD:	Ping			FINISH	Hui	Sheet	4 from 6



Solder Condition

Lead Free Solder

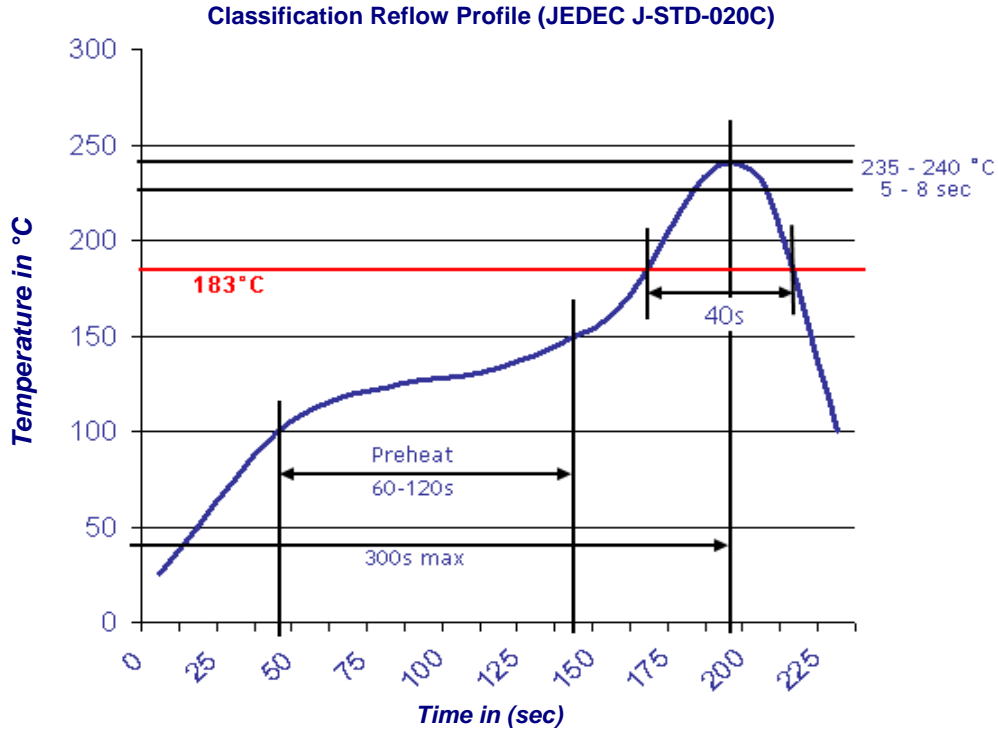

Super Flux Warm White	
Part No.:	M13G1002
Customer:	

DRW:	Dong	CHKD	Chang	MATL:	Chui	DATE	22.10.2010
APPD:	Ping			FINISH	Hui	Sheet	5 from 6



Color table curve

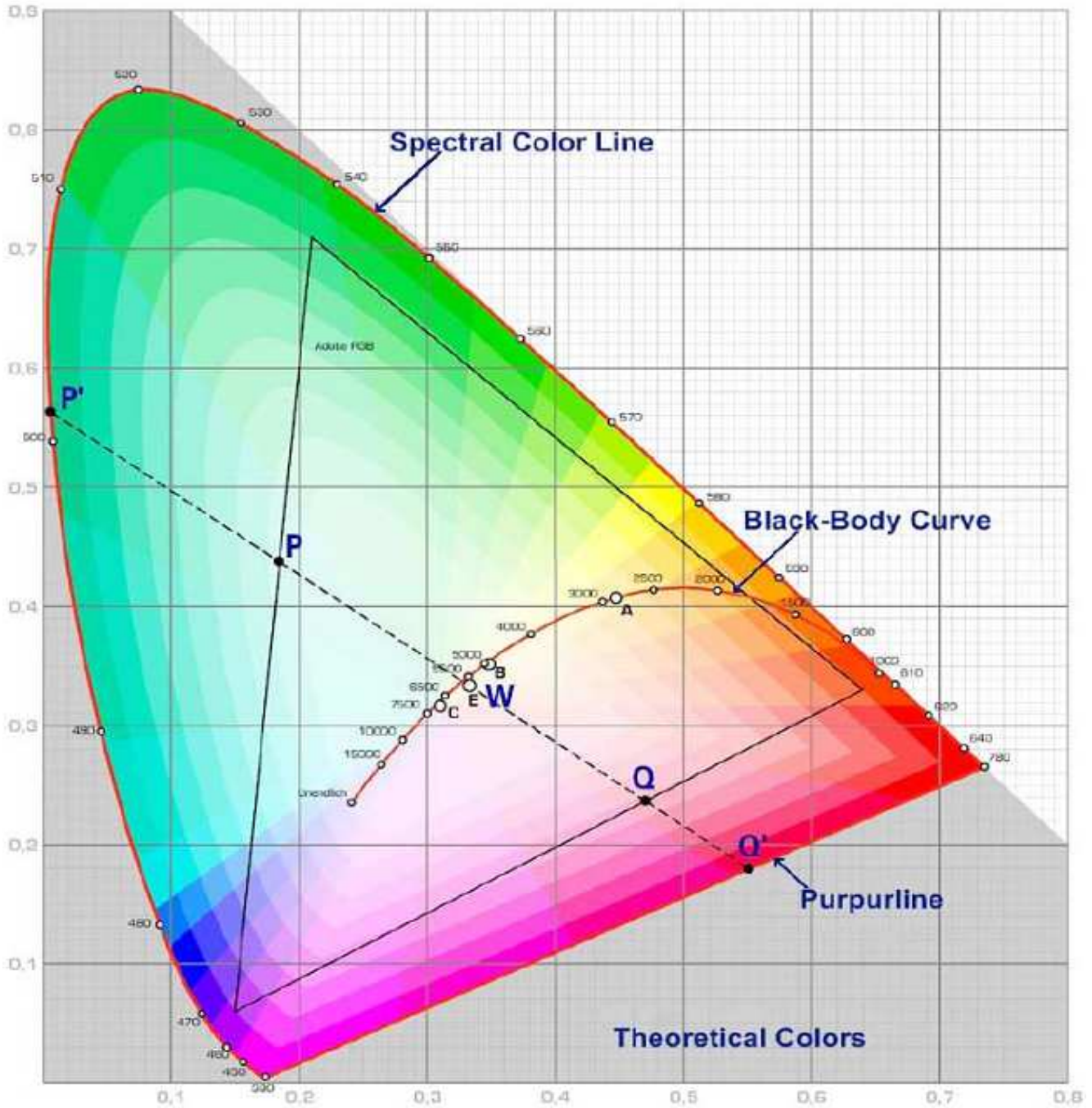

Super Flux Warm White	
Part No.:	M13G1002
Customer:	

DRW:	Dong	CHKD	Chang	MATL:	Chui	DATE	22.10.2010
APPD:	Ping			FINISH	Hui	Sheet	6 from 6