

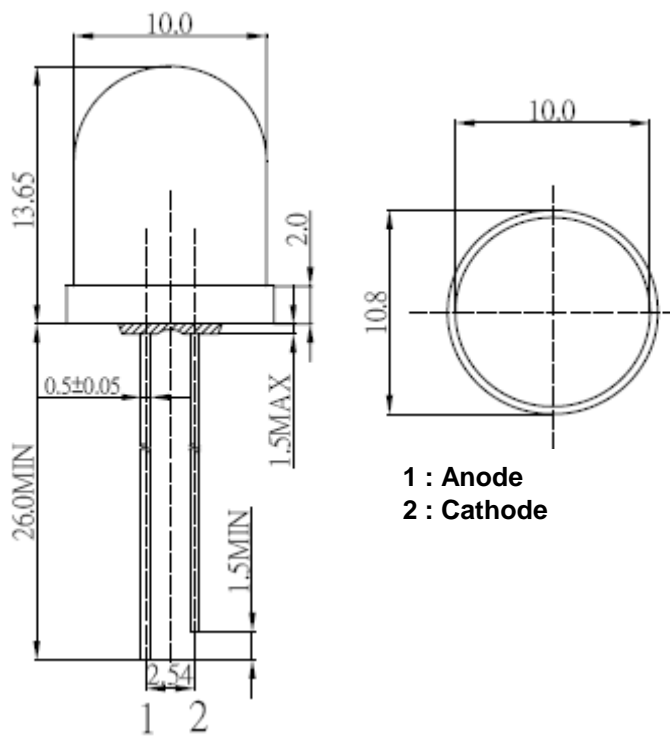

Applications

- Electronic Signs and Signals
- Small Area Illuminations
- Back Lighting
- Other Lighting

Technical Drawing



Notes :

All dimensions in mm tolerance is $\pm 0.1\text{mm}$ unless otherwise noted.

Round LED Violet	
Part No.:	M13B1023
Customer:	

DRW:	Dong	CHKD	Chang	MATL:	Chui	DATE	18.10.2010
APPD:	Ping			FINISH	Hui	Sheet	1 from 6



Absolute Maximum Ratings

Ta=25°C

Item	Symbol	---	Unit
Power Dissipation	P _D	108	mW
DC Forward Current	I _F	30	mA
Pulsed Forward Current	I _{FP} *	100	mA
Reverse Voltage	V _R	5	V
Operating Temperature	T _{OP}	-30 to 85	°C
Storage Temperature	T _{ST}	-40 to 100	°C

* 0.1 msec pulse, 10% duty cycle

Electrcal / Optical Characteristics

Ermitting Color	Violet		
Material	---		
Forward Voltage	typ.	3.1	V _F
	max.	3.6	V _F
Wavelength typ.	λ _D	400 ~ 410	nm
	λ _P	---	nm
	Δλ	---	nm
Color Temperature	min.	---	K
	max.	---	K
Luminous Intensity *	min.	150	mcd
	typ.	200	mcd
Reverse Current	max.	---	μA
Viewing Angle	2Θ _{1/2}	30	

* Per NIST standards

Round LED
Violet

Part No.: **M13B1023**

Customer:

DRW:	Dong	CHKD	Chang	MATL:	Chui	DATE	18.10.2010
APPD:	Ping			FINISH	Hui	Sheet	2 from 6



Directive Characteristics

**Round LED
Violet**

Part No.: **M13B1023**

Customer:

DRW:	Dong	CHKD	Chang	MATL:	Chui	DATE	18.10.2010
APPD:	Ping			FINISH	Hui	Sheet	3 from 6

Copyright by EDCON-COMPONENTS



Typical Characteristics

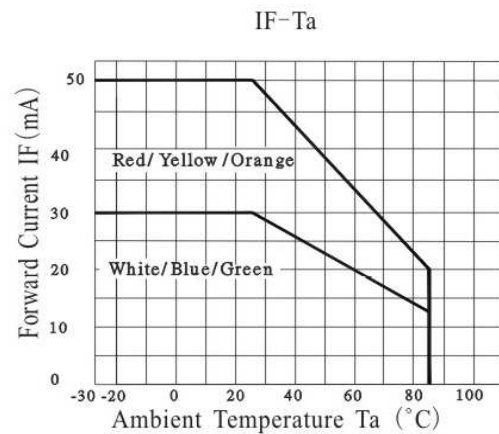
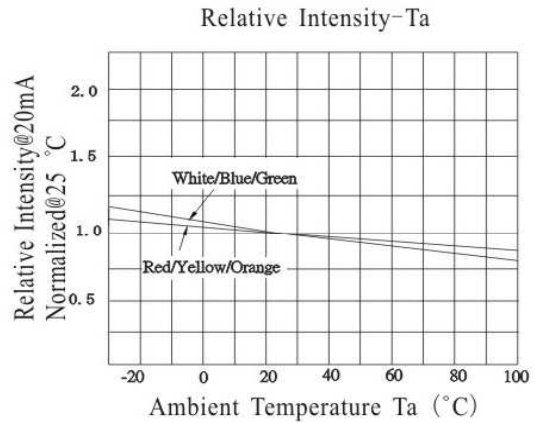
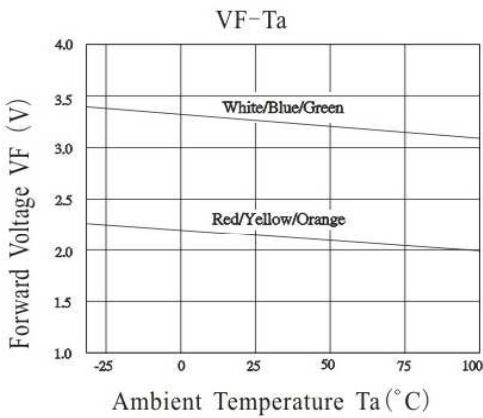
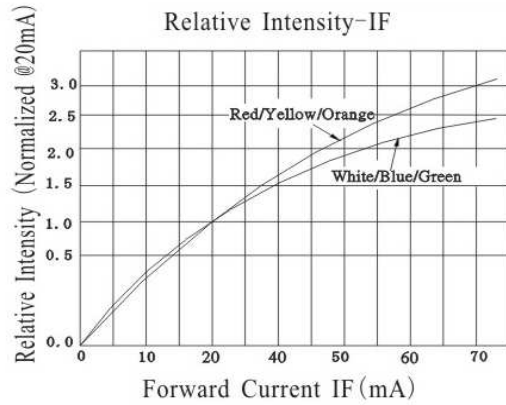
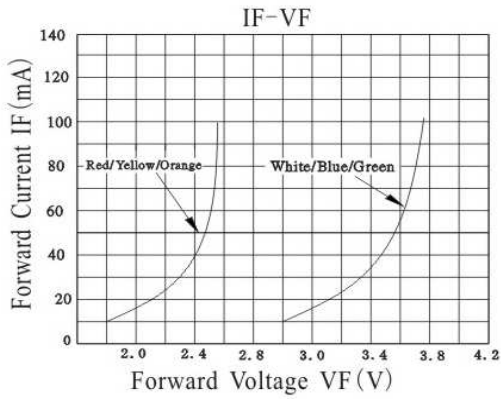

Round LED Violet	
Part No.:	M13B1023
Customer:	

DRW:	Dong	CHKD	Chang	MATL:	Chui	DATE	18.10.2010
APPD:	Ping			FINISH	Hui	Sheet	4 from 6



Solder Condition

Lead Free Solder



Round LED Violet	
Part No.:	M13B1023
Customer:	

DRW:	Dong	CHKD	Chang	MATL:	Chui	DATE	18.10.2010
APPD:	Ping			FINISH	Hui	Sheet	5 from 6



Color table curve

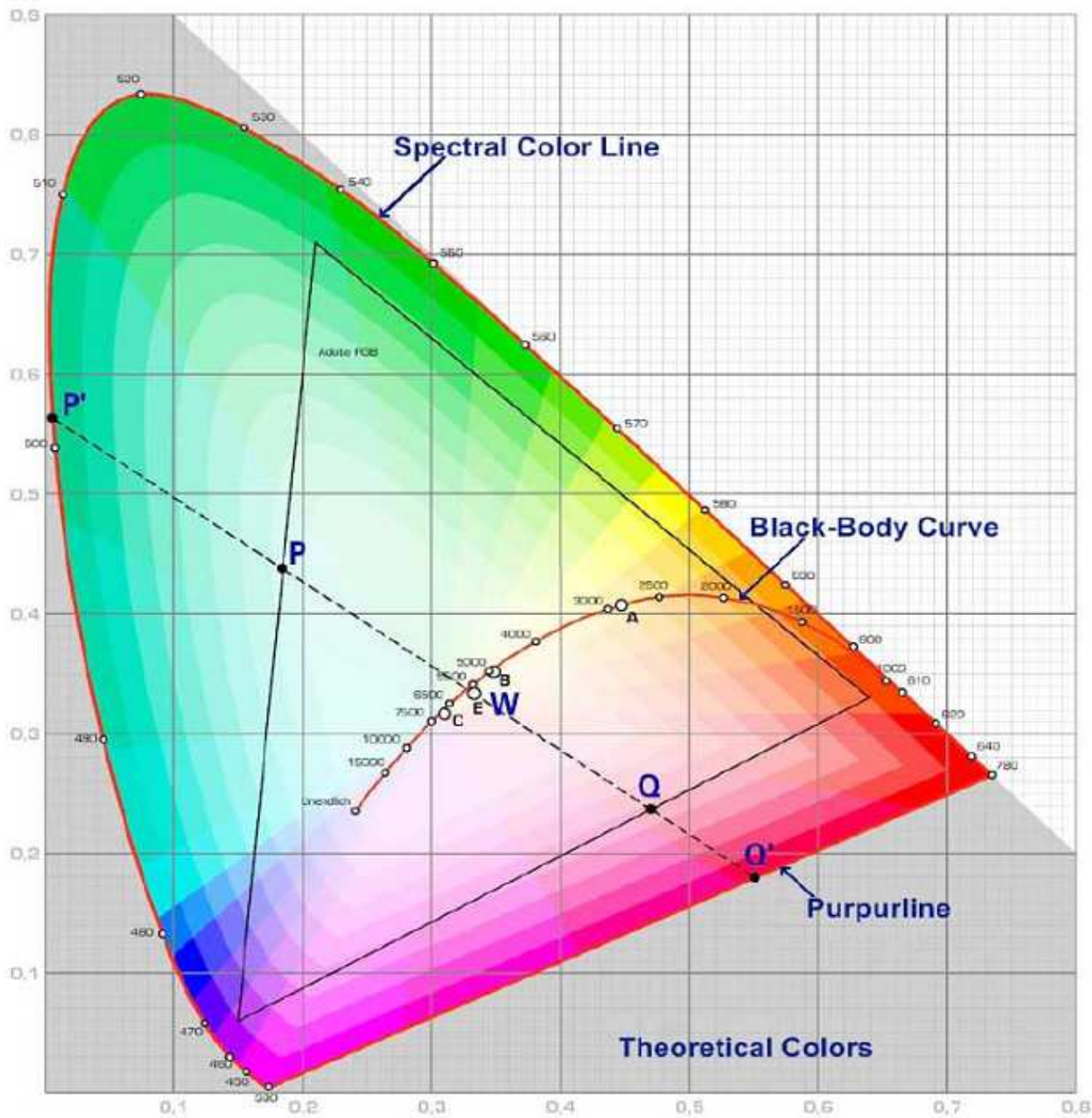

Round LED Violet	
Part No.:	M13B1023
Customer:	

DRW:	Dong	CHKD	Chang	MATL:	Chui	DATE	18.10.2010
APPD:	Ping			FINISH	Hui	Sheet	6 from 6

Copyright by EDCON-COMPONENTS