

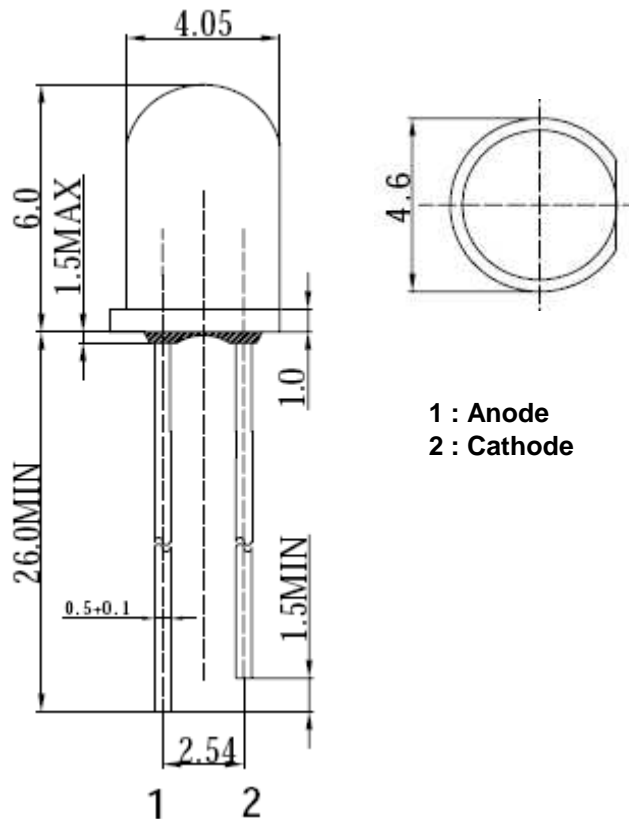

Applications

- Electronic Signs and Signals
- Small Area Illuminations
 - Back Lighting
 - Other Lighting

Technical Drawing



1 : Anode
 2 : Cathode

Notes :

All dimensions in mm tolerance is ± 0.1 mm unless otherwise noted.

Round LED Yellow	
Part No.:	M13A6007
Customer:	

DRW:	Dong	CHKD	Chang	MATL:	Chui	DATE	04.12.2009
APPD:	Ping			FINISH	Hui	Sheet	1 from 6



Absolute Maximum Ratings

Ta=25°C

<i>Item</i>	<i>Symbol</i>	<i>---</i>	<i>Unit</i>
Power Dissipation	P _D	130	mW
DC Forward Current	I _F	50	mA
Pulsed Forward Current	I _{FP} *	120	mA
Reverse Voltage	V _R	5	V
Operating Temperature	T _{OP}	-30 ~ 85	°C
Storage Temperature	T _{ST}	-40 ~ 100	°C

* 0.1 msec pulse, 10% duty cycle

Electrcal / Optical Characteristics

Ermittig Color	Yellow		
Material	---		
Forward Voltage	typ.	2.1	V _F
	max.	2.6	V _F
Wavelength typ.	λ _D	585 ~ 590	nm
	λ _P	---	nm
	Δλ	---	nm
Color Temperature	min.	---	K
	max.	---	K
Luminous Intensity *	min.	8400	mcd
	typ.	10000	mcd
Reverse Current	max.	---	μA
Viewing Angle	2Θ _{1/2}	30	

* Per NIST standards

Round LED
Yellow

Part No.: **M13A6007**

Customer:

DRW:	Dong	CHKD	Chang	MATL:	Chui	DATE	04.12.2009
APPD:	Ping			FINISH	Hui	Sheet	2 from 6



Directive Characteristics

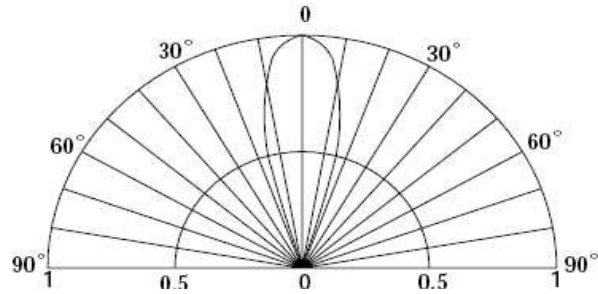

**Round LED
Yellow**

Part No.: **M13A6007**

Customer:

DRW:	Dong	CHKD	Chang	MATL:	Chui	DATE	04.12.2009
APPD:	Ping			FINISH	Hui	Sheet	3 from 6



Typical Characteristics

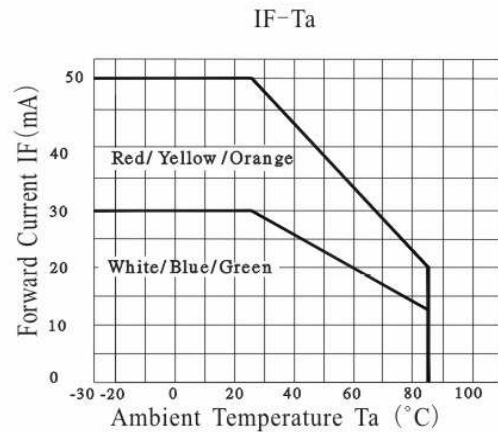
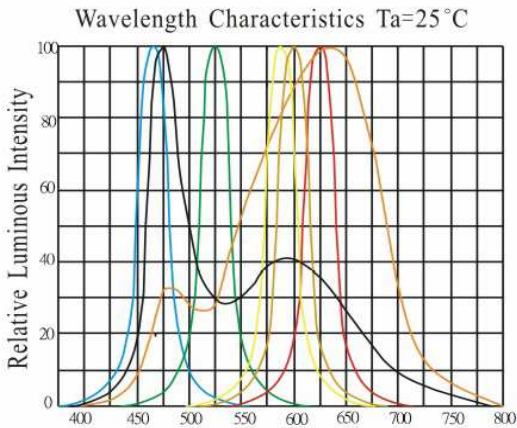
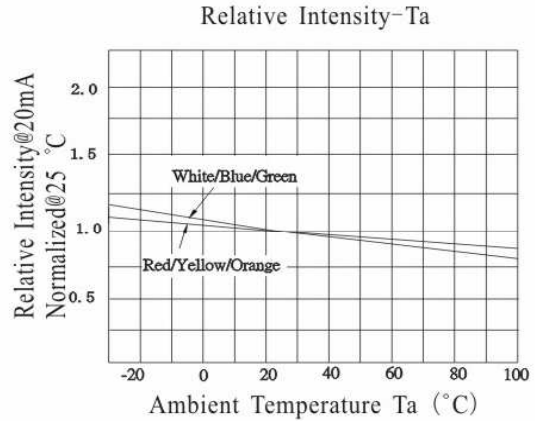
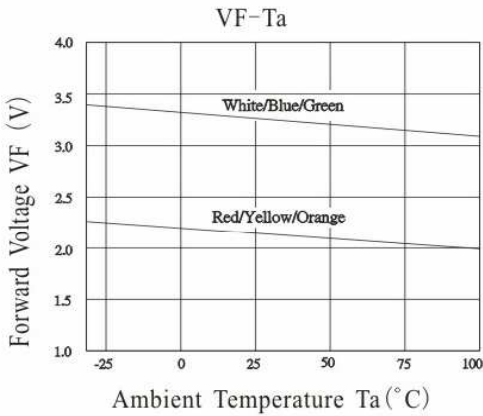
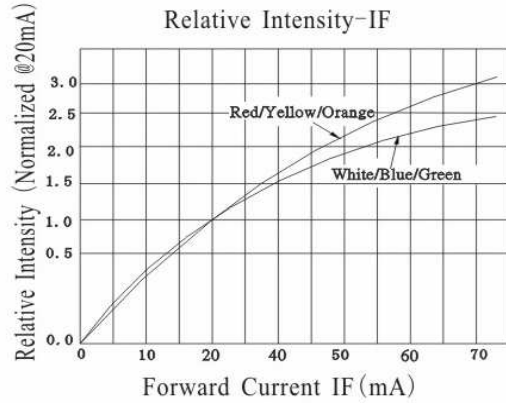
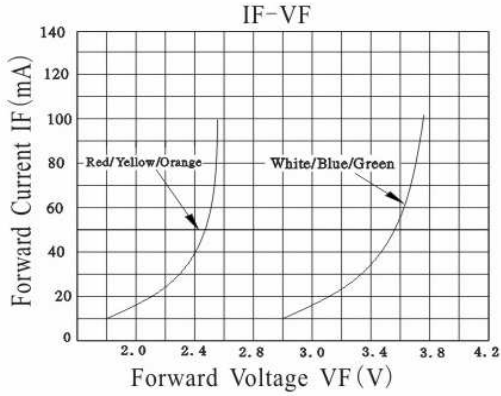

Round LED Yellow	
Part No.:	M13A6007
Customer:	

DRW:	Dong	CHKD	Chang	MATL:	Chui	DATE	04.12.2009
APPD:	Ping			FINISH	Hui	Sheet	4 from 6



Solder Condition

Lead Free Solder

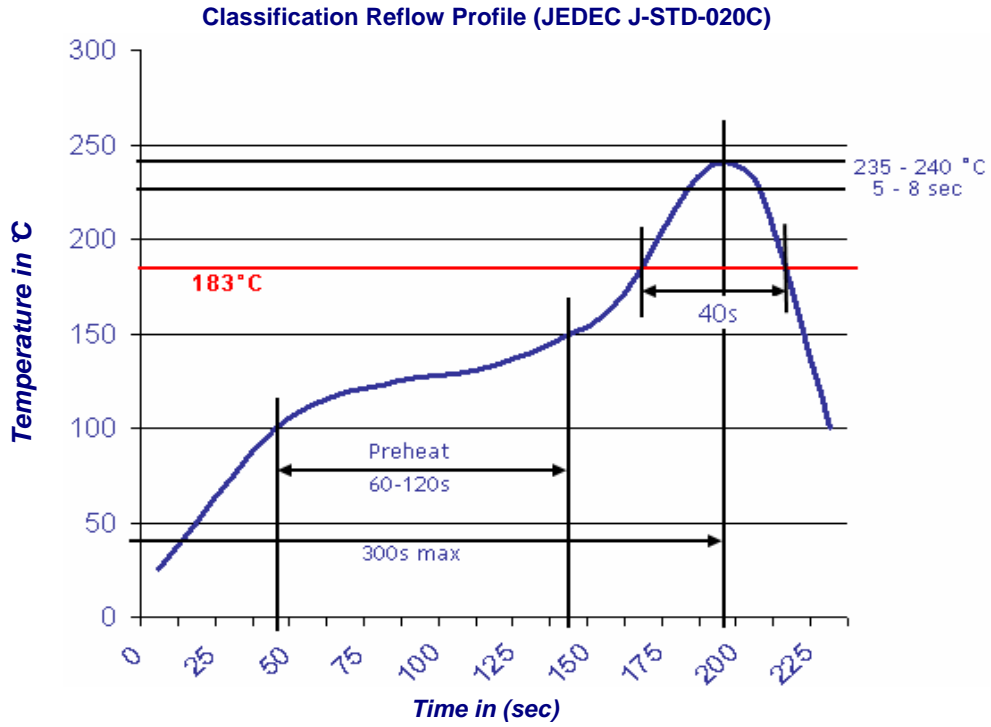

Round LED Yellow	
Part No.:	M13A6007
Customer:	

DRW:	Dong	CHKD	Chang	MATL:	Chui	DATE	04.12.2009
APPD:	Ping			FINISH	Hui	Sheet	5 from 6



Color table curve

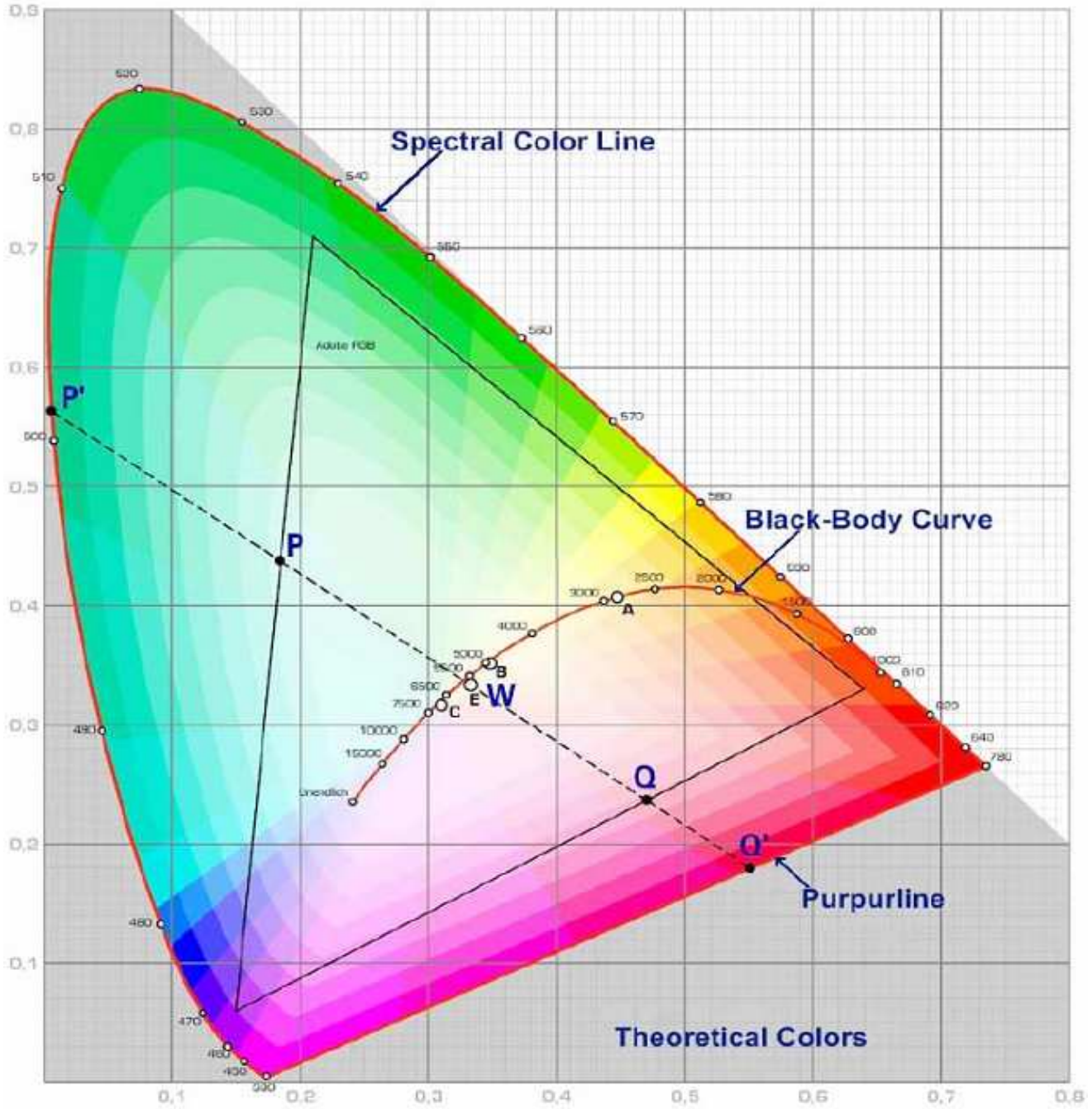

Round LED Yellow	
Part No.:	M13A6007
Customer:	

DRW:	Dong	CHKD	Chang	MATL:	Chui	DATE	04.12.2009
APPD:	Ping			FINISH	Hui	Sheet	6 from 6

Copyright by EDCON-COMPONENTS