

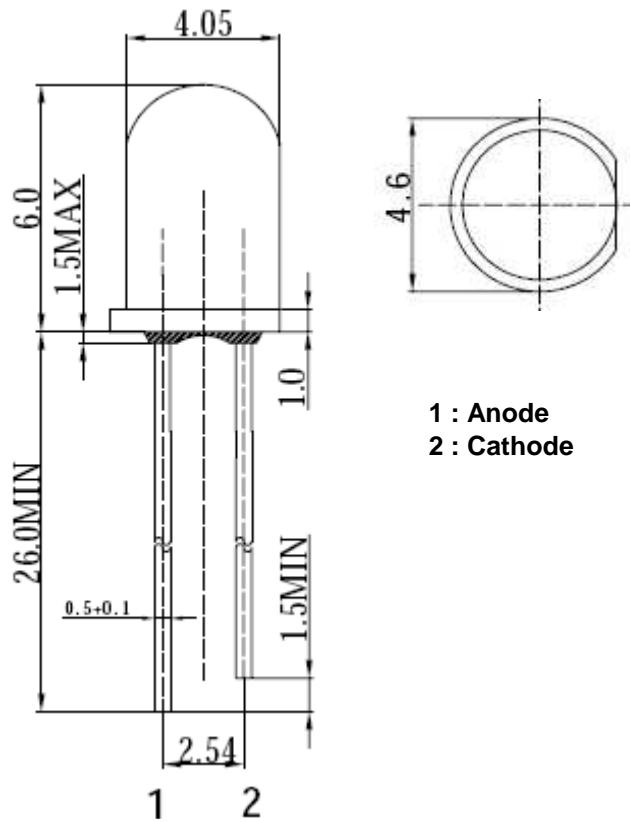

Applications

- Electronic Signs and Signals
- Small Area Illuminations
- Back Lighting
- Other Lighting

Technical Drawing



Notes :

All dimensions in mm tolerance is $\pm 0.1\text{mm}$ unless otherwise noted.

Round LED Orange	
Part No.:	M13A6003
Customer:	

DRW:	Dong	CHKD	Chang	MATL:	Chui	DATE	04.12.2009
APPD:	Ping			FINISH	Hui	Sheet	1 from 6



Absolute Maximum Ratings

Ta=25°C

Item	Symbol	---	Unit
Power Dissipation	P _D	---	mW
DC Forward Current	I _F	20	mA
Pulsed Forward Current	I _{FP} *	---	mA
Reverse Voltage	V _R	---	V
Operating Temperature	T _{OP}	---	°C
Storage Temperature	T _{ST}	-55 to 100	°C

* 0.1 msec pulse, 10% duty cycle

Electrical / Optical Characteristics

I_F=20mA Ta=25°C

Ermitting Color	Orange		
Material	---		
Forward Voltage	typ.	2.1	V _F
	max.	2.6	V _F
Wavelength typ.	λ _D	600	nm
	λ _P	605	nm
	Δλ	---	nm
Color Temperature	min.	---	K
	max.	---	K
Luminous Intensity *	min.	5800	mcd
	typ.	7000	mcd
Reverse Current	max.	---	μA
Viewing Angle	2Θ1/2	30	

* Per NIST standards

Round LED
Orange

Part No.: **M13A6003**

Customer:

DRW:	Dong	CHKD	Chang	MATL:	Chui	DATE	04.12.2009
APPD:	Ping			FINISH	Hui	Sheet	2 from 6



Directive Characteristics

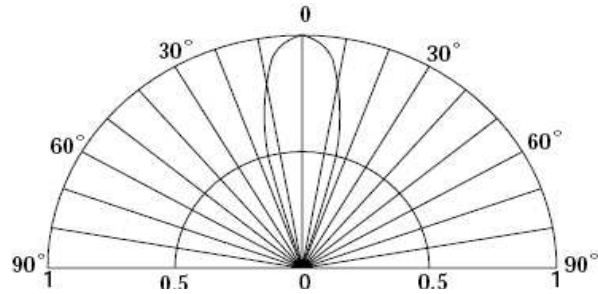

Round LED Orange	
Part No.:	M13A6003
Customer:	

DRW:	Dong	CHKD	Chang	MATL:	Chui	DATE	04.12.2009
APPD:	Ping			FINISH	Hui	Sheet	3 from 6



Typical Characteristics

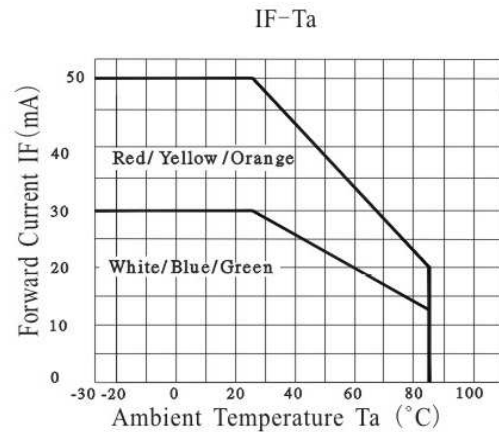
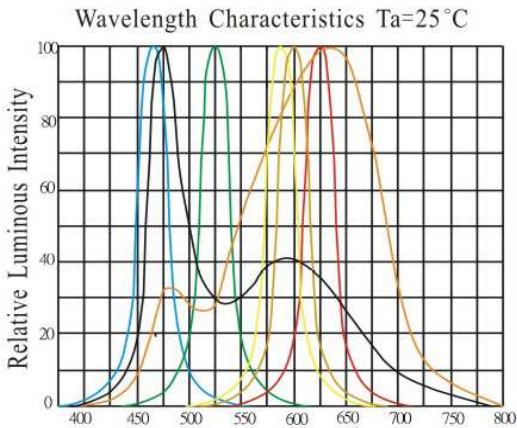
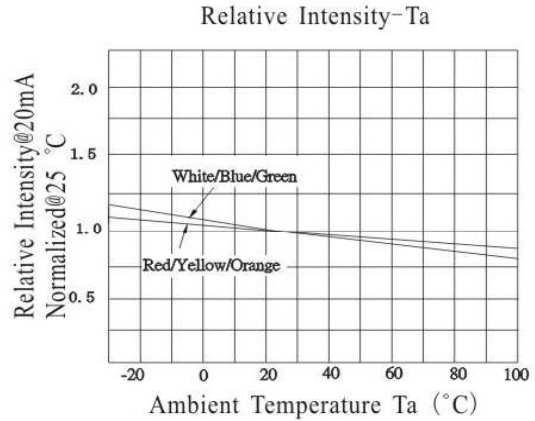
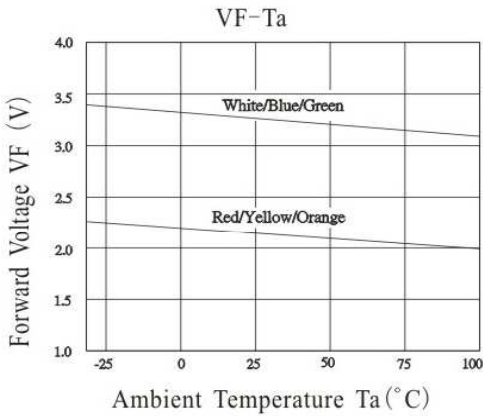
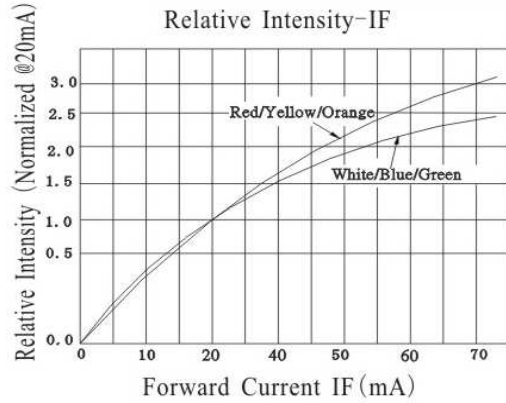
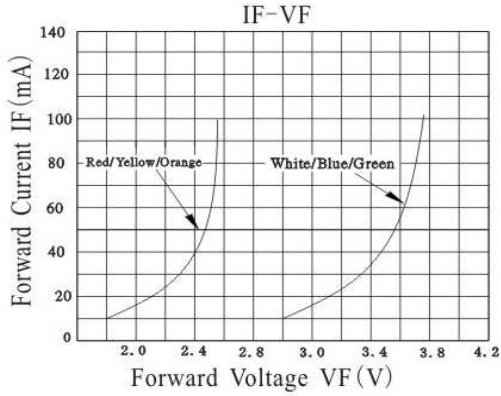

Round LED Orange	
Part No.:	M13A6003
Customer:	

DRW:	Dong	CHKD	Chang	MATL:	Chui	DATE	04.12.2009
APPD:	Ping			FINISH	Hui	Sheet	4 from 6



Solder Condition

Lead Free Solder

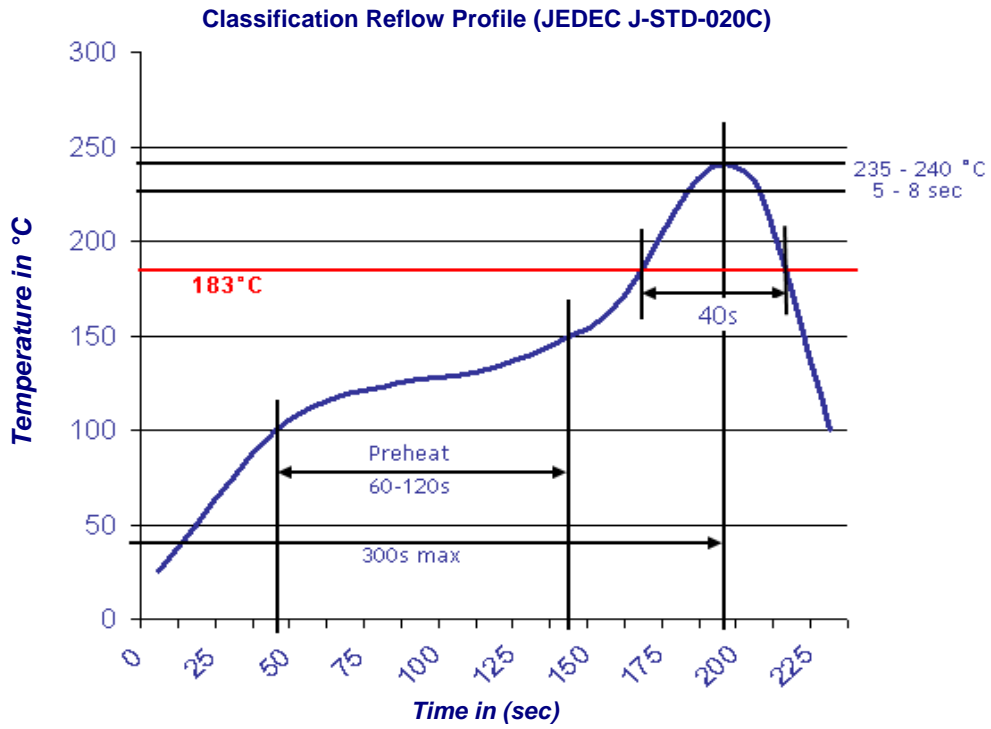

Round LED Orange	
Part No.:	M13A6003
Customer:	

DRW:	Dong	CHKD	Chang	MATL:	Chui	DATE	04.12.2009
APPD:	Ping			FINISH	Hui	Sheet	5 from 6



Color table curve

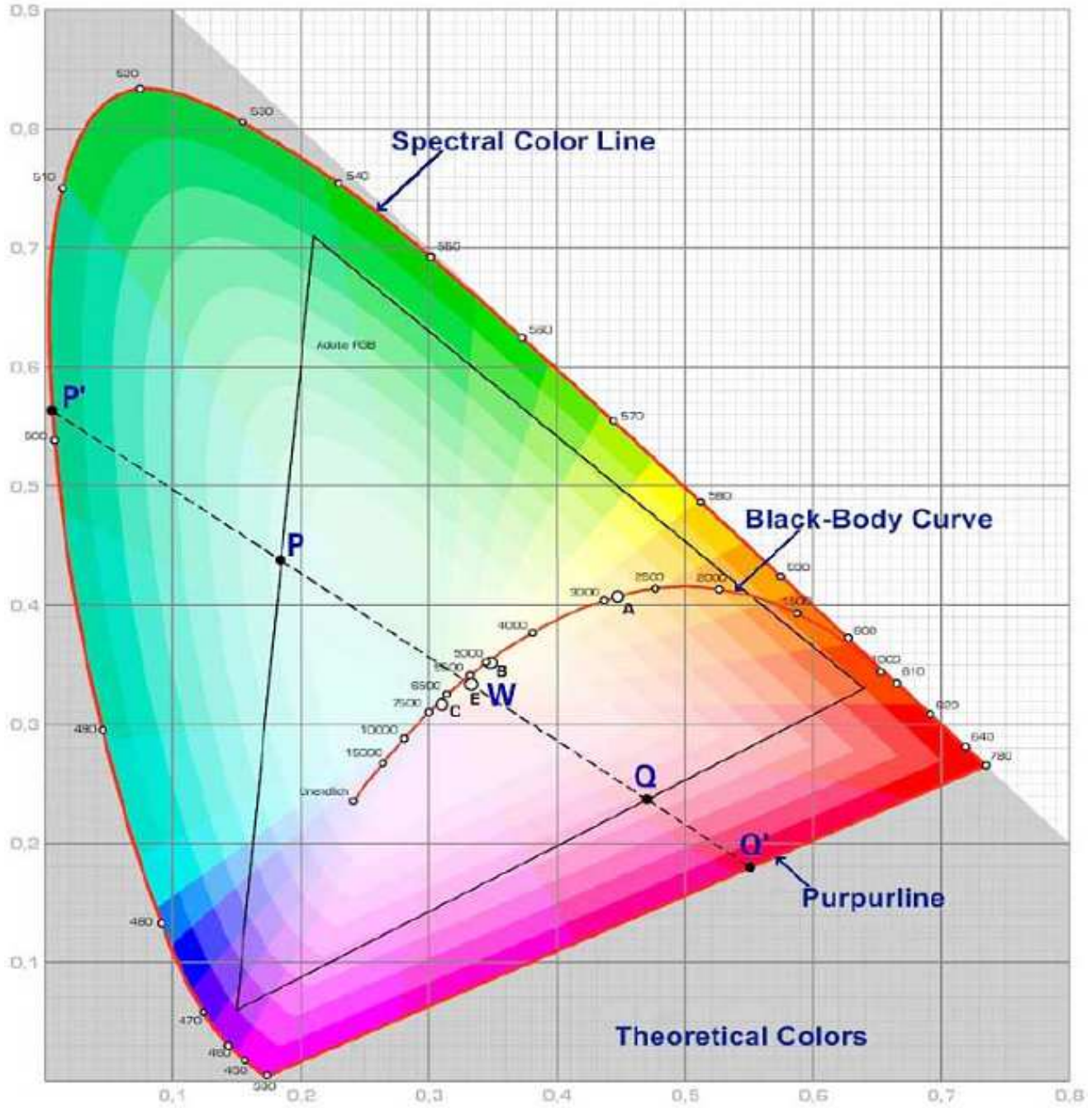

Round LED Orange	
Part No.:	M13A6003
Customer:	

DRW:	Dong	CHKD	Chang	MATL:	Chui	DATE	04.12.2009
APPD:	Ping			FINISH	Hui	Sheet	6 from 6

Copyright by EDCON-COMPONENTS