

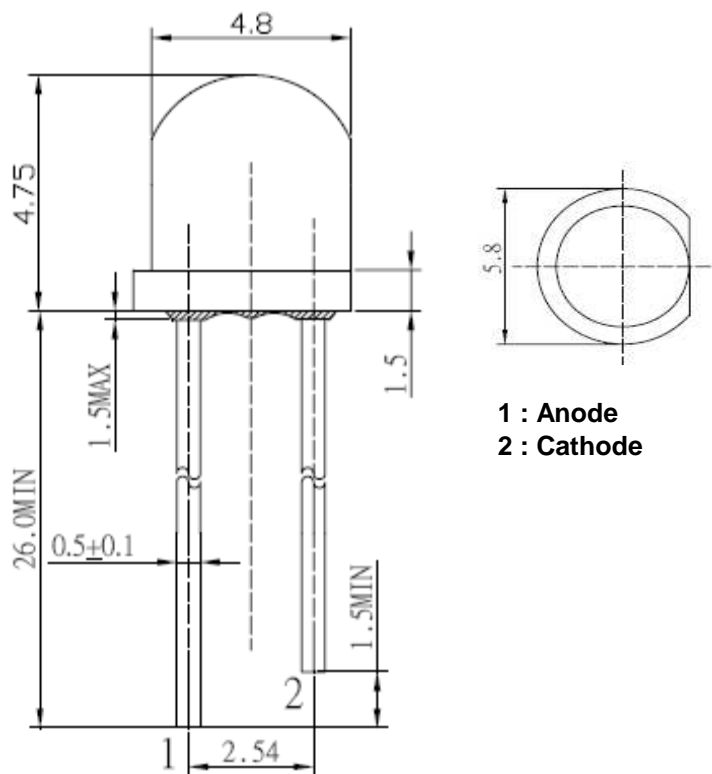

Applications

- Electronic Signs and Signals
- Small Area Illuminations
- Back Lighting
- Other Lighting

Technical Drawing



1 : Anode
 2 : Cathode

Notes :

All dimensions in mm tolerance is $\pm 0.1\text{mm}$ unless otherwise noted.

Straw LED Red	
Part No.:	M13A4006
Customer:	

DRW:	Dong	CHKD	Chang	MATL:	Chui	DATE	06.12.2009
APPD:	Ping			FINISH	Hui	Sheet	1 from 6



Absolute Maximum Ratings

Ta=25°C

Item	Symbol	---	Unit
Power Dissipation	P _D	130	mW
DC Forward Current	I _F	50	mA
Pulsed Forward Current	I _{FP} *	120	mA
Reverse Voltage	V _R	5	V
Operating Temperature	T _{OP}	-30 to 85	°C
Storage Temperature	T _{ST}	-40 to 100	°C

* 0.1 msec pulse, 10% duty cycle

Electrical / Optical Characteristics

I_F=20mA Ta=25°C

Ermitting Color	Red		
Material	---		
Forward Voltage	typ.	2.1	V _F
	max.	2.6	V _F
Wavelength typ.	λ _D	620	nm
	λ _P	625	nm
	Δλ	---	nm
Color Temperature	min.	---	K
	max.	---	K
Luminous Intensity *	min.	1120	mcd
	typ.	1500	mcd
Reverse Current	max.	10	μA
Viewing Angle	2Θ1/2	100	

* Per NIST standards

Straw LED
Red

Part No.: **M13A4006**

Customer:

DRW:	Dong	CHKD	Chang	MATL:	Chui	DATE	06.12.2009
APPD:	Ping			FINISH	Hui	Sheet	2 from 6



Directive Characteristics

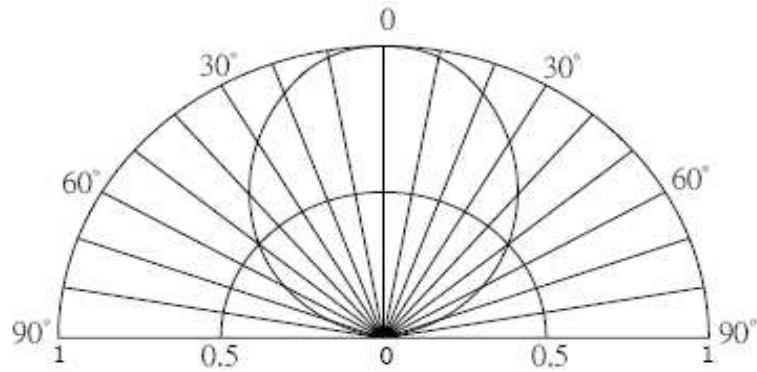

Straw LED
Red

Part No.: **M13A4006**

Customer:

DRW:	Dong	CHKD	Chang	MATL:	Chui	DATE	06.12.2009
APPD:	Ping			FINISH	Hui	Sheet	3 from 6



Typical Characteristics

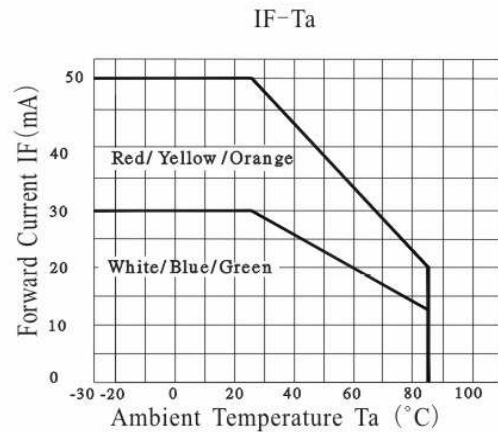
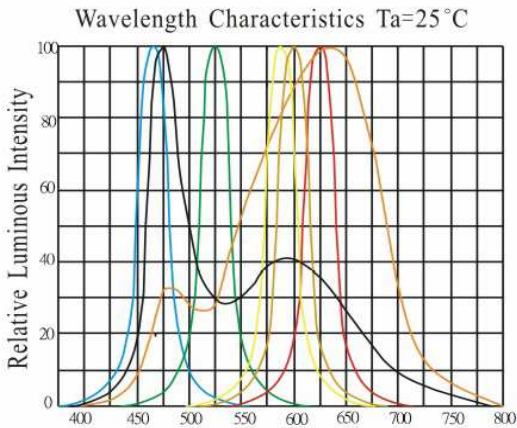
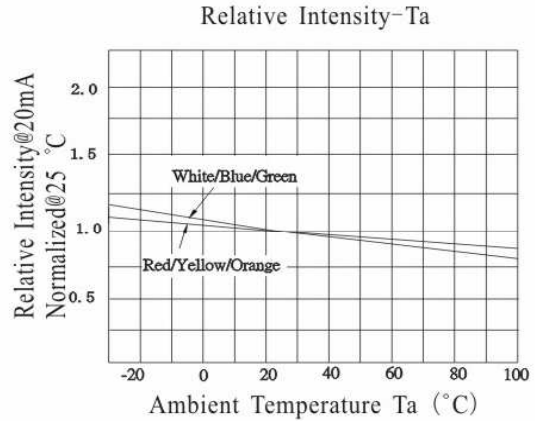
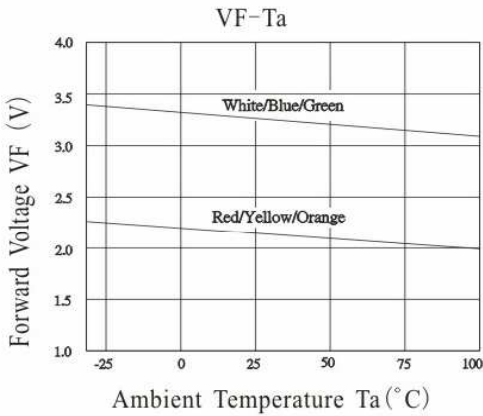
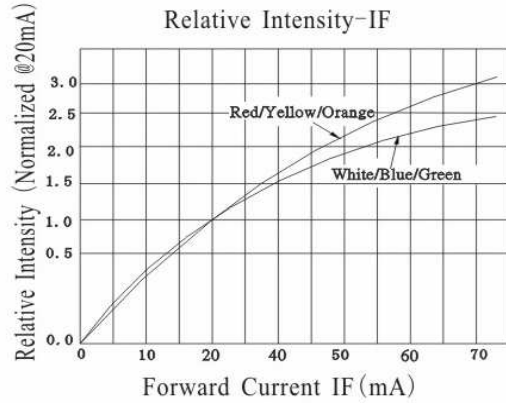
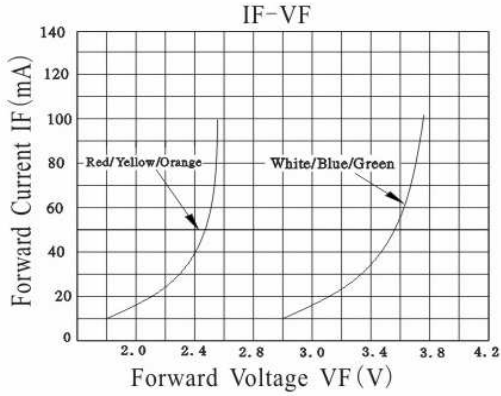

Straw LED Red	
Part No.:	M13A4006
Customer:	

DRW:	Dong	CHKD	Chang	MATL:	Chui	DATE	06.12.2009
APPD:	Ping			FINISH	Hui	Sheet	4 from 6



Solder Condition

Lead Free Solder

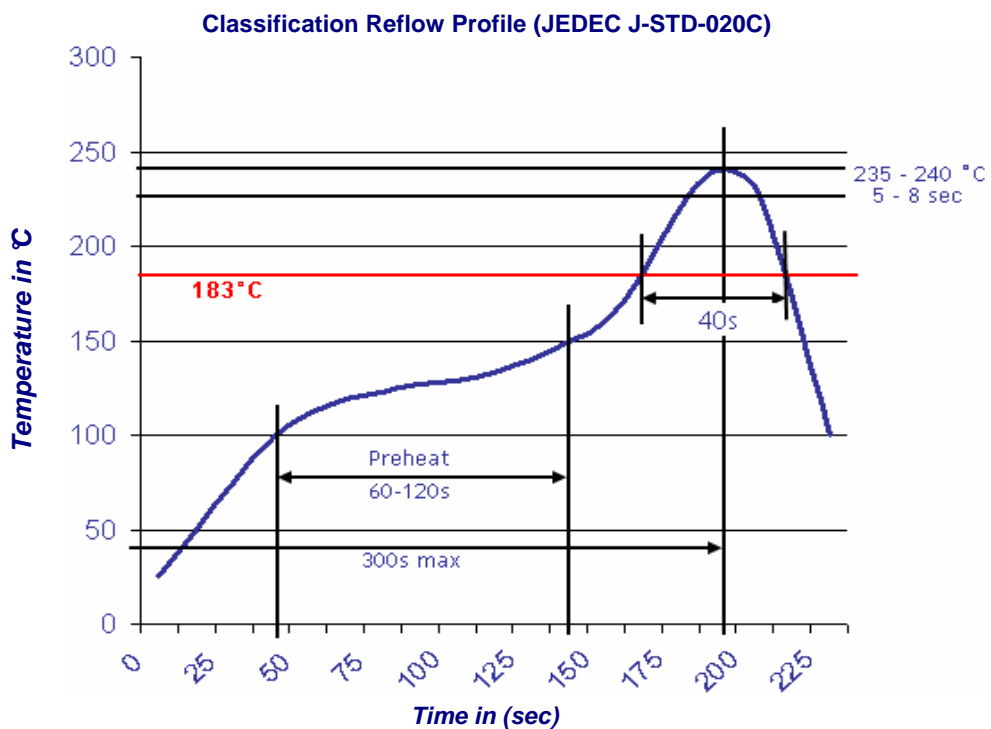

Straw LED Red	
Part No.:	M13A4006
Customer:	

DRW:	Dong	CHKD	Chang	MATL:	Chui	DATE	06.12.2009
APPD:	Ping			FINISH	Hui	Sheet	5 from 6



Color table curve



Straw LED Red	
Part No.:	M13A4006
Customer:	

DRW:	Dong	CHKD	Chang	MATL:	Chui	DATE	06.12.2009
APPD:	Ping			FINISH	Hui	Sheet	6 from 6

Copyright by EDCON-COMPONENTS