

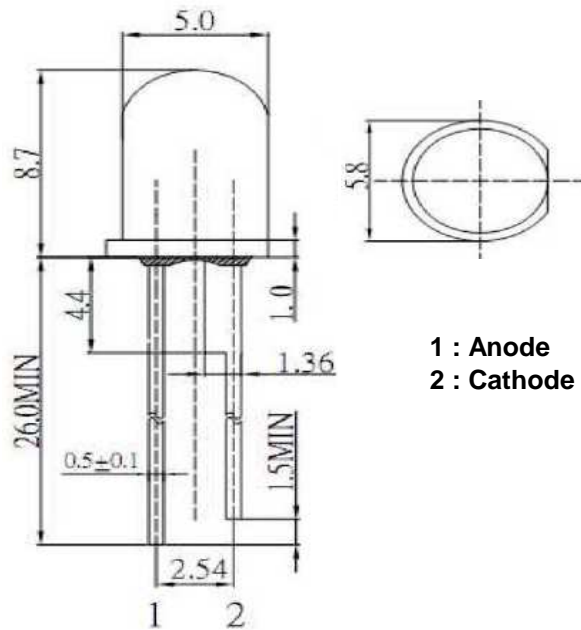

**Applications**

- Electronic Signs and Signals
- Small Area Illuminations
- Back Lighting
- Other Lighting

**Technical Drawing**



1 : Anode  
 2 : Cathode

**Notes :**

All dimensions in mm tolerance is ± 0.1mm unless otherwise noted.

<b>Round LED</b> <b>Red</b>	
Part No.:	<b>M13A3099</b>
Customer:	

DRW:	Dong	CHKD	Chang	MATL:	Chui	DATE	04.12.2009
APPD:	Ping			FINISH	Hui	Sheet	1 from 6



**Absolute Maximum Ratings**

Ta=25°C

Item	Symbol	---	Unit
Power Dissipation	P <sub>D</sub>	120	mW
DC Forward Current	I <sub>F</sub>	50	mA
Pulsed Forward Current	I <sub>FP</sub> *	120	mA
Reverse Voltage	V <sub>R</sub>	5	V
Operating Temperature	T <sub>OP</sub>	-30 to 85	°C
Storage Temperature	T <sub>ST</sub>	-40 to 100	°C

\* 0.1 msec pulse, 10% duty cycle

**Electrical / Optical Characteristics**

Ta=25°C

Ermitting Color	Red		
Material	---		
Forward Voltage	typ.	2.1	V <sub>F</sub>
	max.	2.4	V <sub>F</sub>
Wavelength typ.	λ <sub>D</sub>	619	nm
	λ <sub>P</sub>	624	nm
	Δλ	---	nm
Color Temperature	min.	---	K
	max.	---	K
Luminous Intensity *	min.	14400	mcd
	typ.	18000	mcd
Reverse Current	max.	---	μA
Viewing Angle	2Θ1/2	15	

\* Per NIST standards

**Round LED**  
**Red**

Part No.: **M13A3099**

Customer:

DRW:	Dong	CHKD	Chang	MATL:	Chui	DATE	04.12.2009
APPD:	Ping			FINISH	Hui	Sheet	2 from 6



**Order Informations**

Order Number	-	Packing
--------------	---	---------

<b>M13A3099</b>	-	<b>XX</b>
-----------------	---	-----------

<b>LL</b> = Long Lead
<b>L4</b> = Lead length 4 mm
<b>TB</b> = Tape Box
<b>TR</b> = Tape Reel
<b>IV</b> = Individual Packing

**Directive Characteristics**

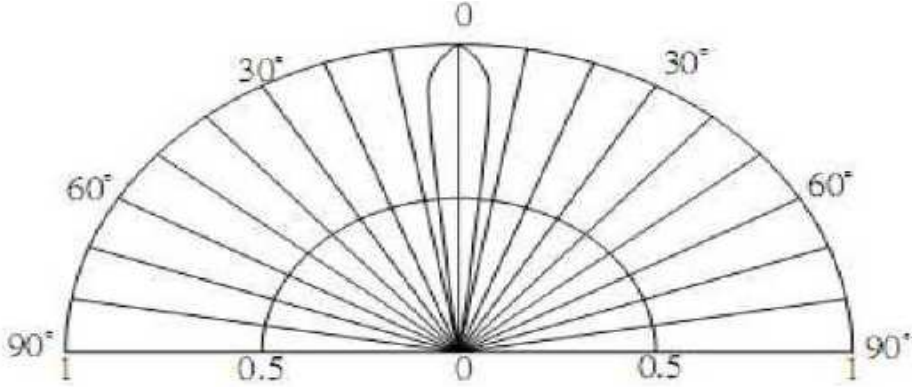

<b>Round LED</b> <b>Red</b>			
Part No.:		<b>M13A3099</b>	
Customer:			

DRW:	Dong	CHKD	Chang	MATL:	Chui	DATE	04.12.2009
APPD:	Ping			FINISH	Hui	Sheet	3 from 6



**Typical Characteristics**

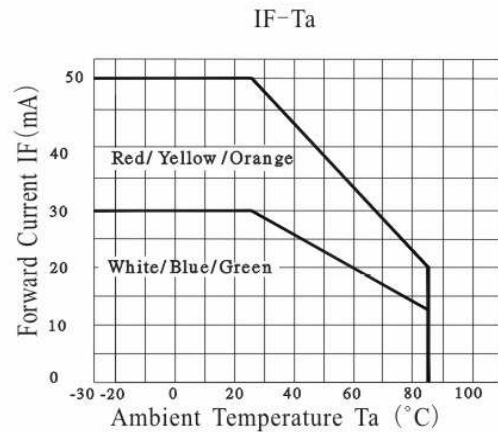
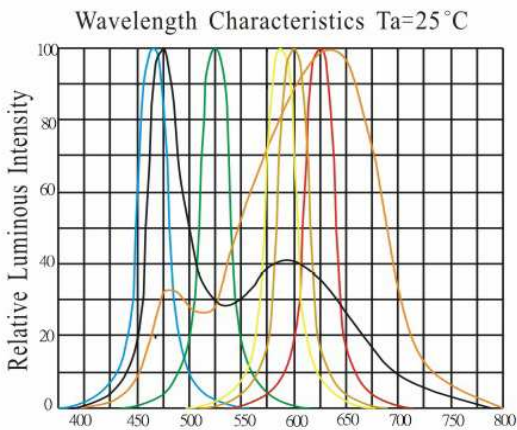
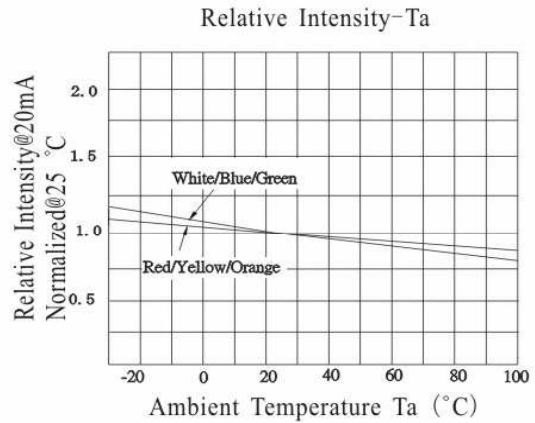
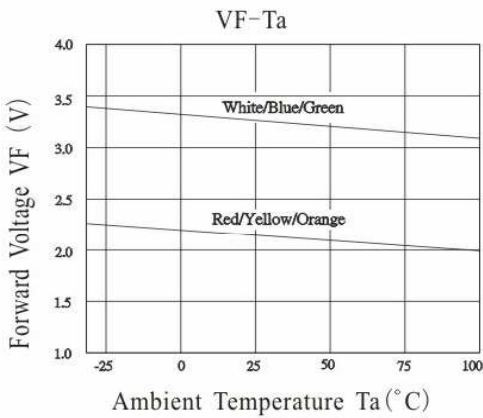
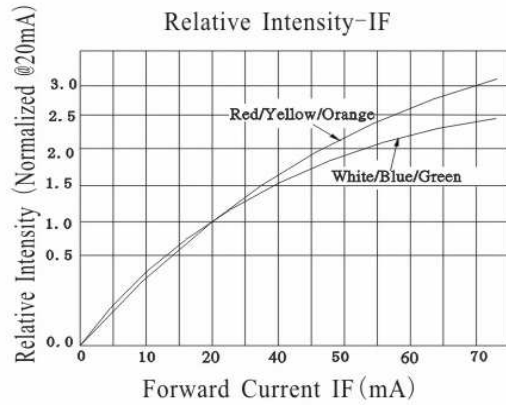
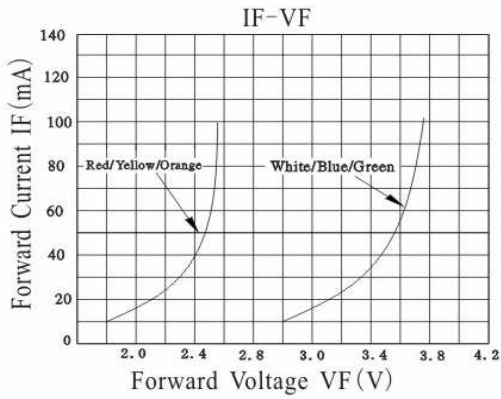

<b>Round LED Red</b>	
Part No.:	<b>M13A3099</b>
Customer:	

DRW:	Dong	CHKD	Chang	MATL:	Chui	DATE	04.12.2009
APPD:	Ping			FINISH	Hui	Sheet	4 from 6



**Solder Condition**

**Lead Free Solder**

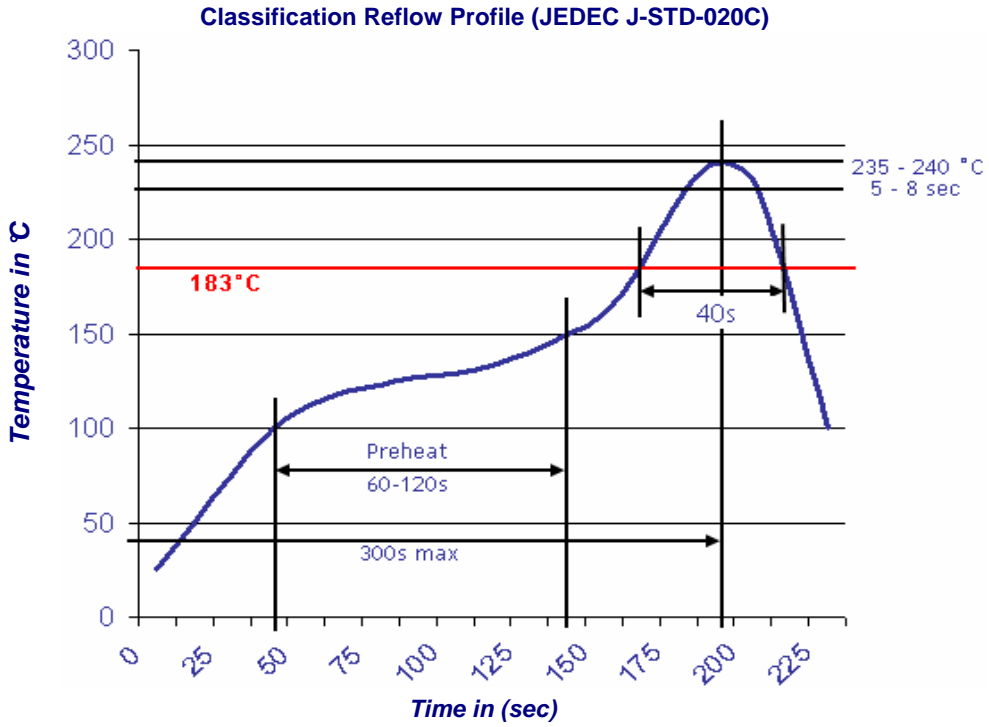

<b>Round LED Red</b>	
Part No.:	<b>M13A3099</b>
Customer:	

DRW:	Dong	CHKD	Chang	MATL:	Chui	DATE	04.12.2009
APPD:	Ping			FINISH	Hui	Sheet	5 from 6



**Color table curve**



<b>Round LED Red</b>	
Part No.:	<b>M13A3099</b>
Customer:	

DRW:	Dong	CHKD	Chang	MATL:	Chui	DATE	04.12.2009
APPD:	Ping			FINISH	Hui	Sheet	6 from 6

Copyright by EDCON-COMPONENTS