

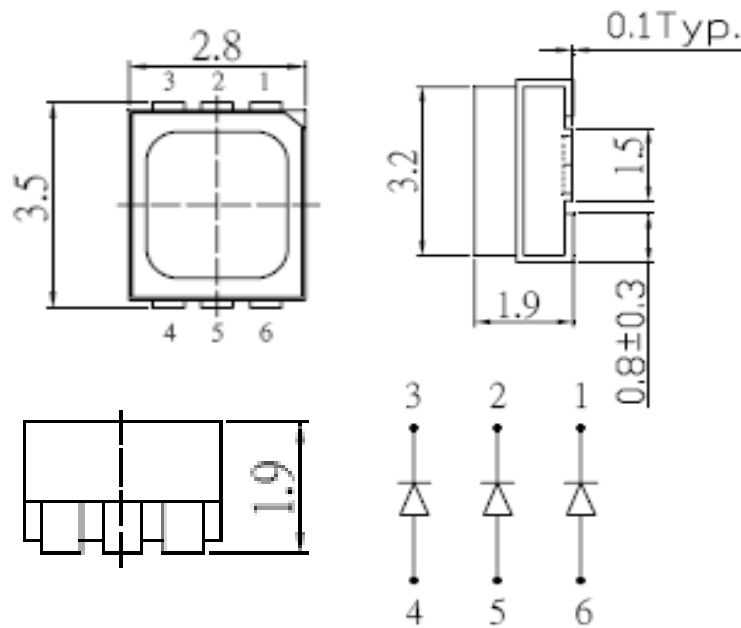

**Applications**

- Interior automotive lighting
- Optical indicators
- Communication Products
- Backlighting
- Toys

**Technical Drawing**



**Notes :**

All dimensions in mm tolerance is  $\pm 0.1\text{mm}$  unless otherwise noted.

<b>PLCC6 Yellow</b>	
Part No.:	<b>M11D2008</b>
Customer:	

DRW:	Dong	CHKD	Chang	MATL:	Chui	DATE	19.11.2010
APPD:	Ping			FINISH	Hui	Sheet	1 from 9



**Absolute Maximum Ratings**

Item	Symbol	---	Unit
Power Dissipation	$P_D$	234	mW
DC Forward Current	$I_F$	90	mA
Pulsed Forward Current	$I_{FP}^*$	100	mA
Reverse Voltage	$V_R$	5	V
Operating Temperature	$T_{OP}$	-30 to 85	°C
Storage Temperature	$T_{ST}$	-40 to 100	°C

\* 0.1 msec pulse, 10% duty cycle

**Electrcal / Optical Characteristics**

Ermitting Color	Yellow		
Material	---		
Forward Voltage	typ.	2.1	$V_F$
	max.	2.6	$V_F$
Wavelength typ.	$\lambda_D$	585 ~ 595	nm
	$\lambda_P$	---	nm
	$\Delta\lambda$	---	nm
Color Temperature	min.	---	K
	max.	---	K
Luminous Intensity *	min.	2180	mcd
	typ.	3000	mcd
Reverse Current	max.	---	$\mu A$
Viewing Angle	2 $\Theta$ 1/2	120	

\* Per NIST standards

<b>PLCC6 Yellow</b>	
Part No.:	<b>M11D2008</b>
Customer:	

DRW:	Dong	CHKD	Chang	MATL:	Chui	DATE	19.11.2010
APPD:	Ping			FINISH	Hui	Sheet	2 from 9



**Directive Characteristics**

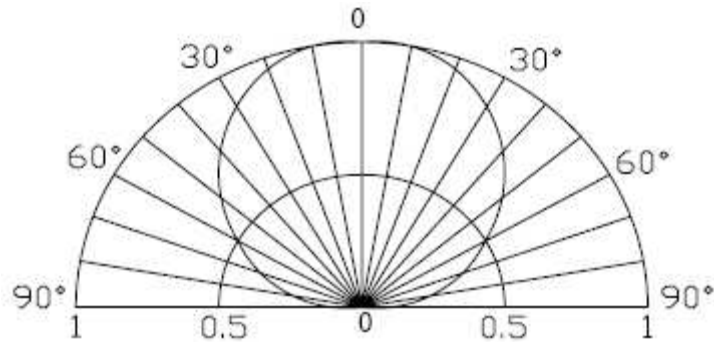

**PLCC6  
Yellow**

Part No.: **M11D2008**

Customer:

DRW:	Dong	CHKD	Chang	MATL:	Chui	DATE	19.11.2010
APPD:	Ping			FINISH	Hui	Sheet	3 from 9



**Typical Characteristics**

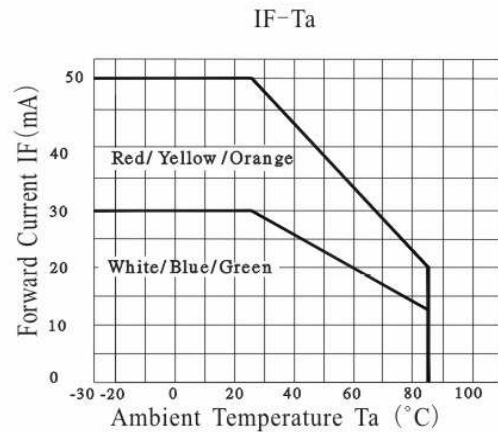
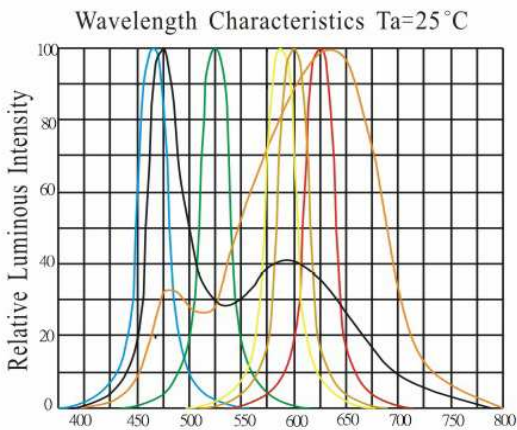
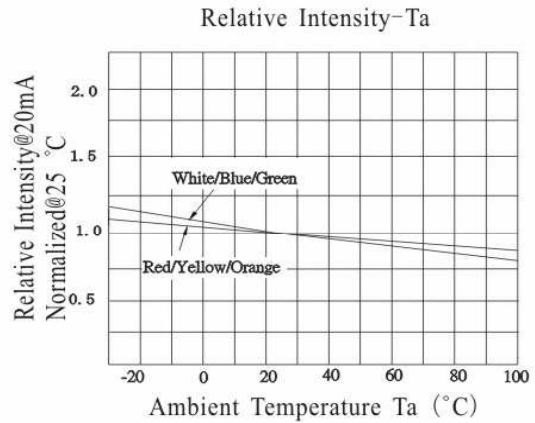
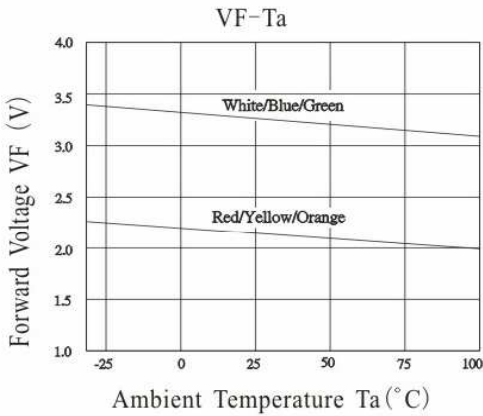
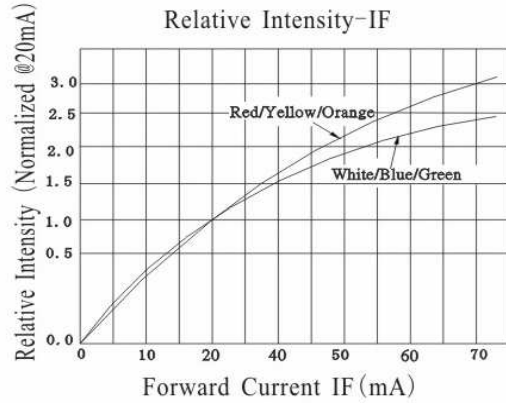
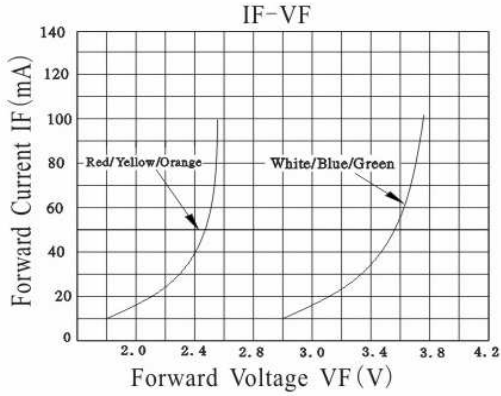

<b>PLCC6 Yellow</b>	
Part No.:	<b>M11D2008</b>
Customer:	

DRW:	Dong	CHKD	Chang	MATL:	Chui	DATE	19.11.2010
APPD:	Ping			FINISH	Hui	Sheet	4 from 9



**Solder Condition**

**Lead Free Solder**

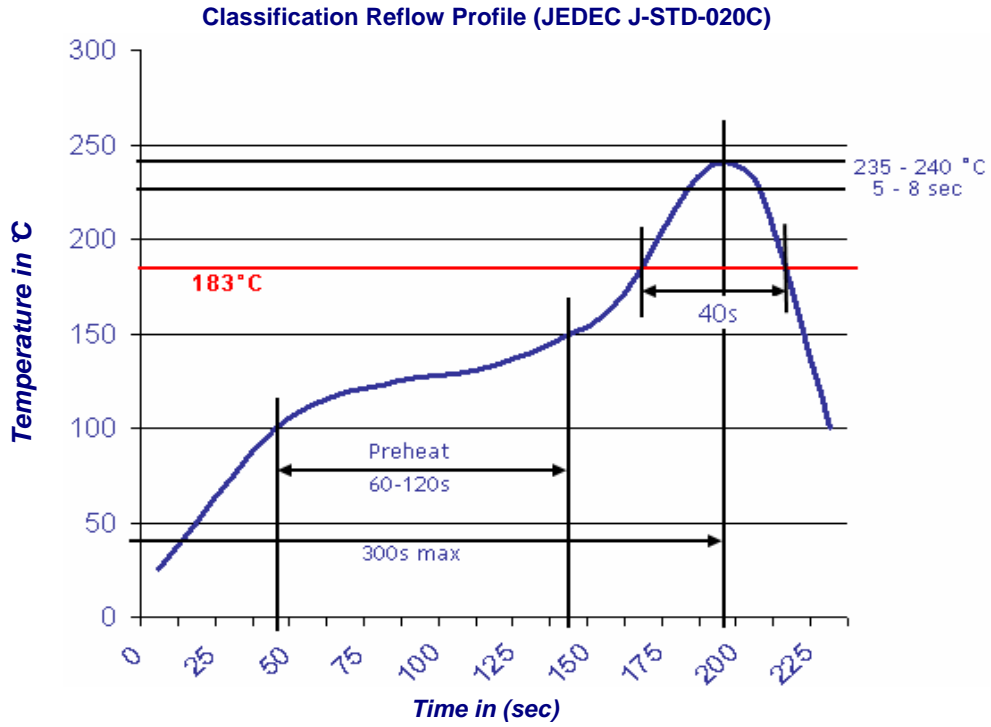

<b>PLCC6 Yellow</b>	
Part No.:	<b>M11D2008</b>
Customer:	

DRW:	Dong	CHKD	Chang	MATL:	Chui	DATE	19.11.2010
APPD:	Ping			FINISH	Hui	Sheet	5 from 9



**Packing Specifications**

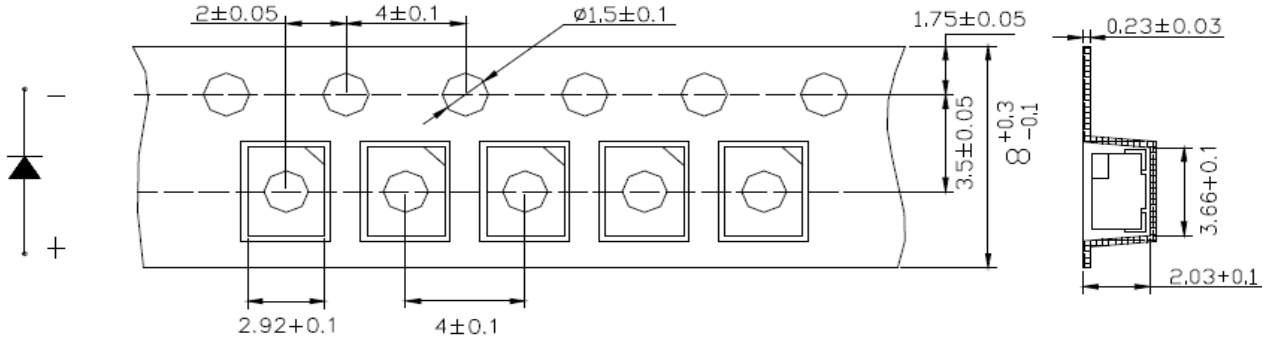

**Reel Specifications**

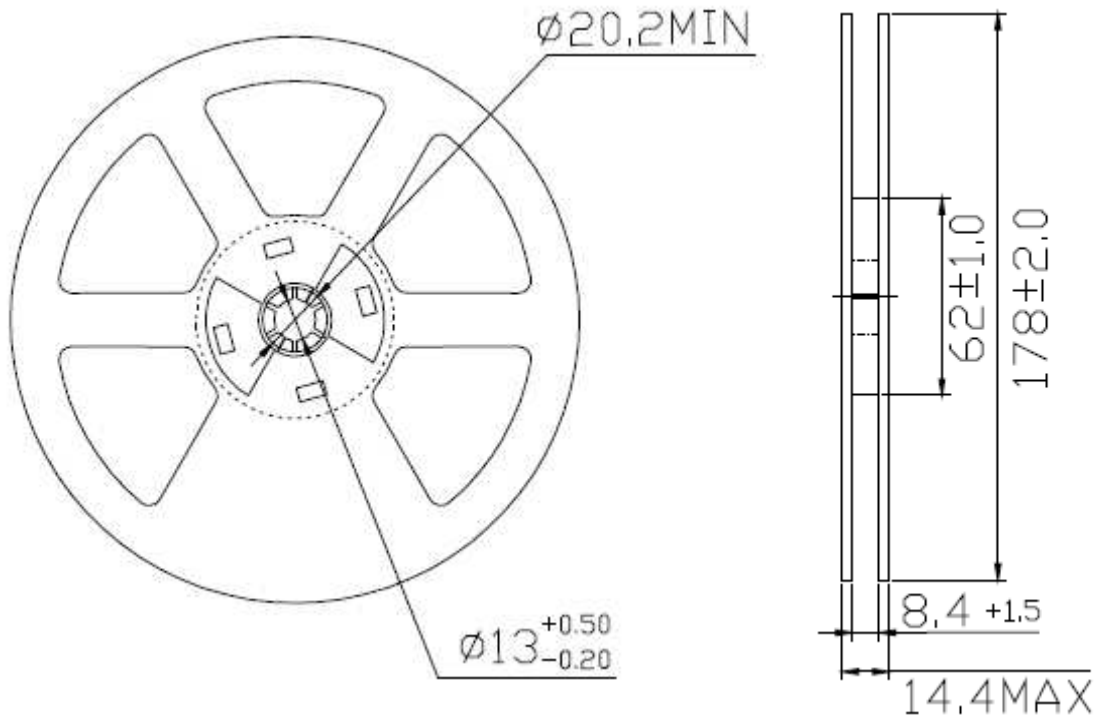

<b>PLCC6 Yellow</b>	
Part No.:	<b>M11D2008</b>
Customer:	

DRW:	Dong	CHKD	Chang	MATL:	Chui	DATE	19.11.2010
APPD:	Ping			FINISH	Hui	Sheet	6 from 9



### Handling Precautions

Compare to epoxy encapsulant that is hard and brittle, silicone is softer and flexible. Although its characteristic significantly reduces thermal stress, it is more susceptible to damage by external mechanical force. As a result, special handling precautions need to be observed during assembly using silicone encapsulated LED products. Failure to comply might lead to damage and premature failure of the LED.

1. Handle the component along the side surfaces by using forceps or appropriate tools

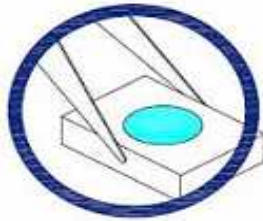

2. Do not directly touch or handle the silicone lens surface. It may damage the internal circuitry.

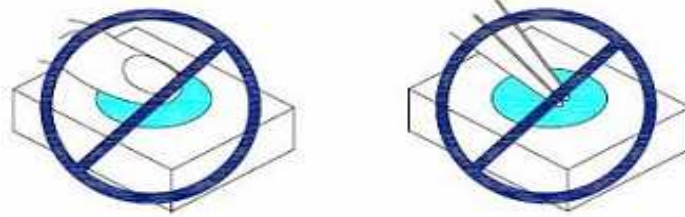

3. Do not stack together assembled PCBs containing exposed LEDs. Outside impact may scratch the silicone lens or damage the internal circuitry.

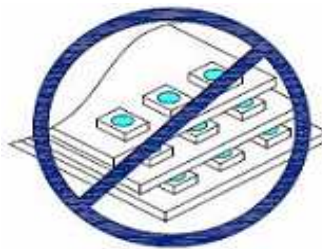

**PLCC6**  
**Yellow**

Part No.: **M11D2008**

Customer:

DRW:	Dong	CHKD	Chang	MATL:	Chui	DATE	19.11.2010
APPD:	Ping			FINISH	Hui	Sheet	7 from 9



4. The outer diameter of the TOP LED pickup nozzle should not exceed the size of the LED to prevent air leaks. The inner diameter of the nozzle should be as large as possible.
5. A pliable material is suggested for the nozzle tip to avoid scratching or damaging the LED surface during pickup.
6. The dimensions of the component must be accurately programmed in the pick-and-place machine to insure precise pickup and avoid damage during production.

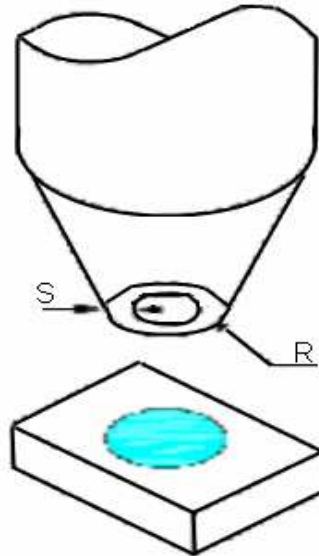

<b>PLCC6 Yellow</b>	
Part No.:	<b>M11D2008</b>
Customer:	

DRW:	Dong	CHKD	Chang	MATL:	Chui	DATE	19.11.2010
APPD:	Ping			FINISH	Hui	Sheet	8 from 9





**Color table curve**

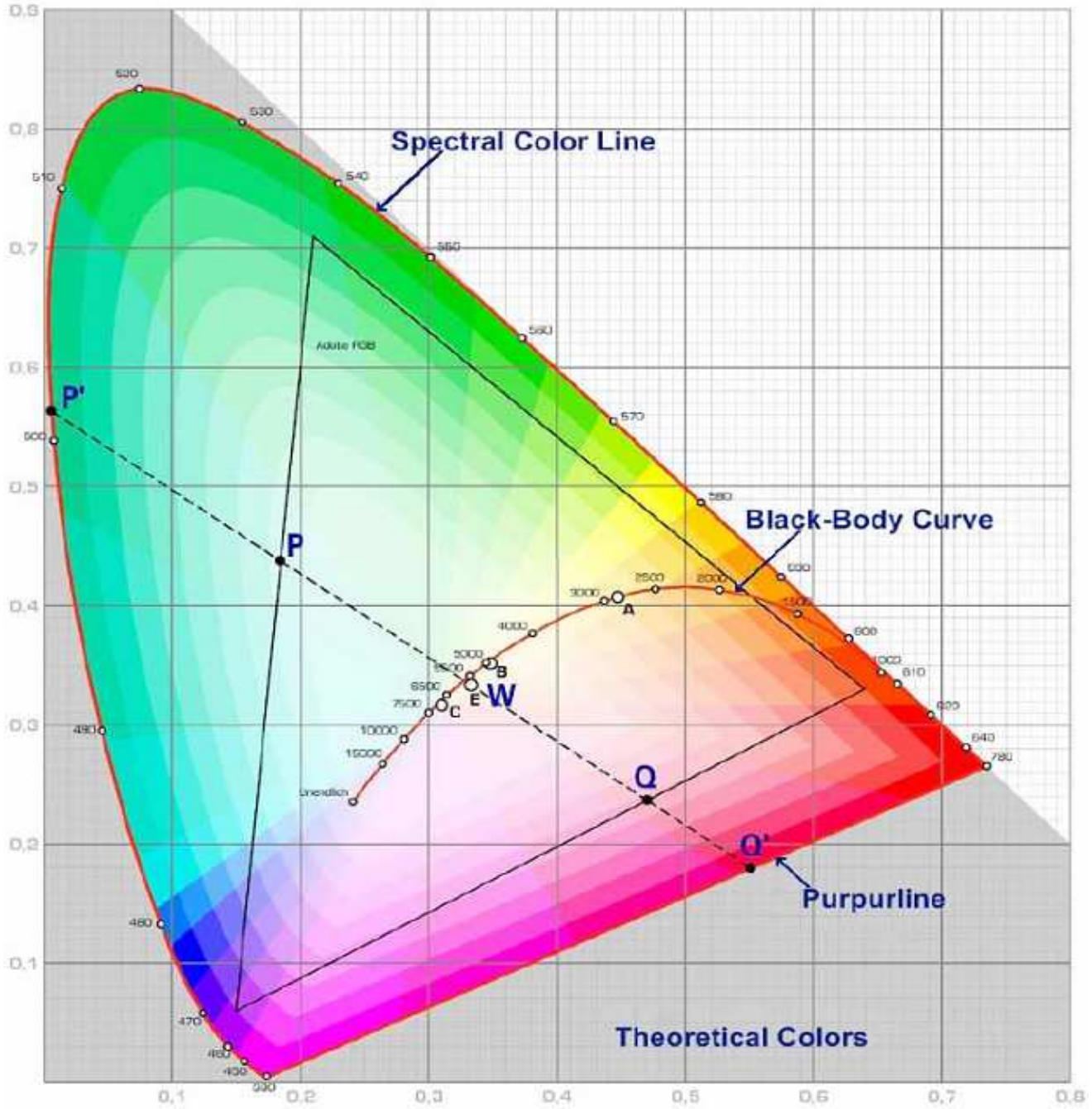

<b>PLCC6 Yellow</b>	
Part No.:	<b>M11D2008</b>
Customer:	

DRW:	Dong	CHKD	Chang	MATL:	Chui	DATE	19.11.2010
APPD:	Ping			FINISH	Hui	Sheet	9 from 9

Copyright by EDCON-COMPONENTS