

# EDCON-COMPONENTS



**Contact**



## SPECIFICATION:

Materials:	Die-casting aluminium alloy
Color:	Alloy
Interlocking Components:	Stainless steel or galvanized steel button
Galvanized Steel:	IP65
Temperatur Range:	.-40°C to +125°C
Flammability acc:	VO (UL94)
Cable Entry:	on panel side
Lever:	no lever

## Technical Drawing

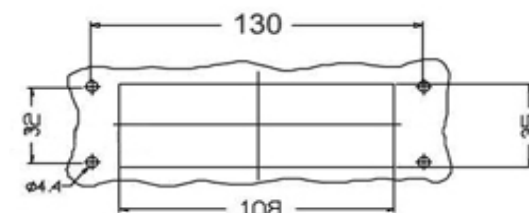
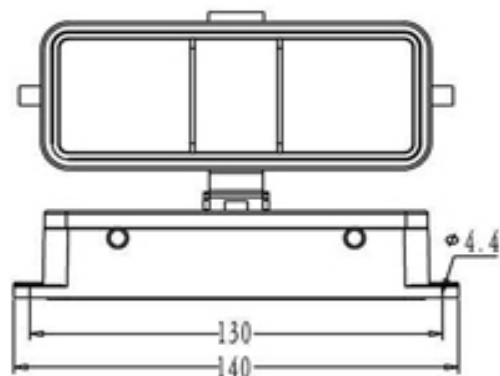
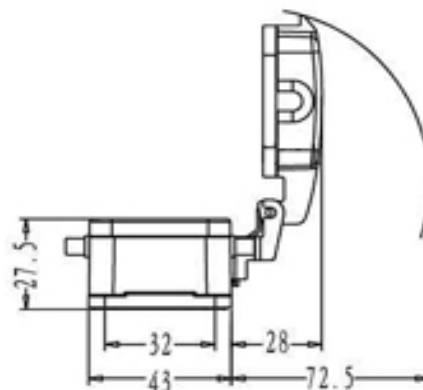

Panel cut out

**Heavy Connector Serie  
HEAV-024**

Part No.: **0973003**

DRW:	Jason	CHKD	Wilson	MATL:	Wilson	TOLERANCE	Mason	DATE	16.08.2010
APPD:	Schumi			FINISH	Jamy		Sheet No.	1 from 2	Customer:

[www.edcon-components.com](http://www.edcon-components.com)

email: [info@edcon-components.com](mailto:info@edcon-components.com)

# EDCON-COMPONENTS



**Contact**



## Ordering Informations

Serie	Thread Type	Size of Thread	ROHS	Packing						
<b>0973003</b>	<b>X</b>	<b>XX</b>	<b>R</b>	<b>CA</b>						

<b>X=</b> No function	<b>XX=</b> No function	<b>R=</b> ROHS Conform	<b>CA=</b> Carton							
		<b>N=</b> NON ROHS Conform								

<b>Heavy Connector Serie HEAV-024</b>
Part No.: <b>0973003</b>
Customer:

DRW:	Jason	CHKD	Wilson	MATL:	Wilson	TOLERANCE	Mason	DATE	16.08.2010
APPD:	Schumi			FINISH	Jamy			Sheet No.	2 from 2