

# EDCON-COMPONENTS



**Contact**



## SPECIFICATION:

Materials:	Die-casting aluminium alloy
Color:	Alloy
Interlocking Components:	Stainless steel or galvanized steel button
Galvanized Steel:	IP65
Temperatur Range:	.-40°C to +125°C
Flammability acc:	VO (UL94)
Cable Entry:	both side
Lever:	two lever

## Technical Drawing

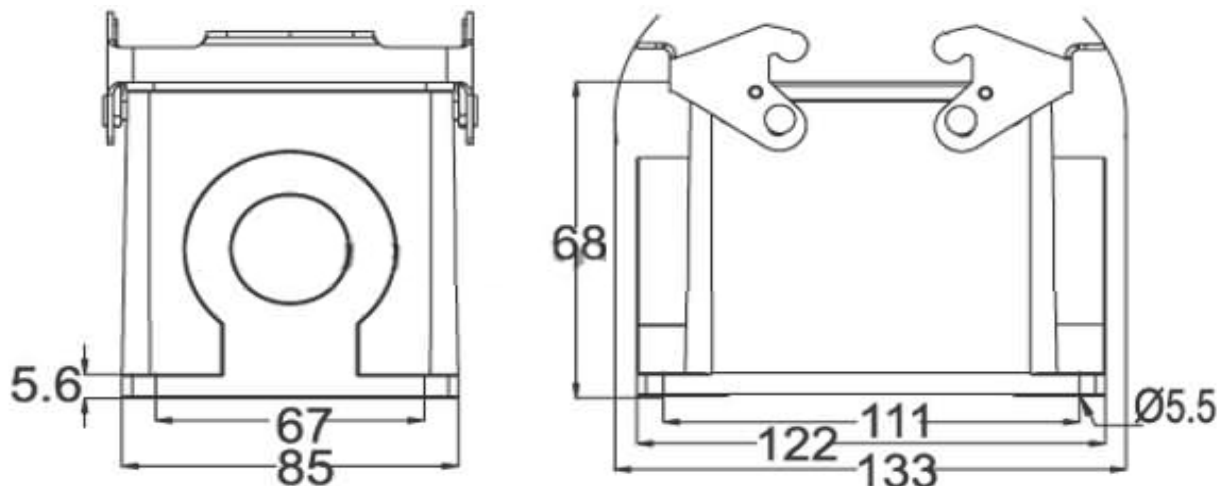

**Heavy Connector Serie  
HDD-144**

Part No.: **0945013**

DRW:	Jason	CHKD	Wilson	MATL:	Wilson	TOLERANCE	Mason	DATE	16.08.2010	Customer:
APPD:	Schumi			FINISH	Jamy		Sheet No.	1 from 2		

[www.edcon-components.com](http://www.edcon-components.com)

email: [info@edcon-components.com](mailto:info@edcon-components.com)

# EDCON-COMPONENTS



**Contact**



## Ordering Informations

Serie	Thread Type	Size of Thread	ROHS	Packing						
<b>0945013</b>	<b>X</b>	<b>XX</b>	<b>R</b>	<b>CA</b>						

		R= ROHS Conform	CA= Carton				
M= M-Thread	32 = M32	N= NON ROHS Conform					
P= PG Thread	232 = 2xM32						
	40 = M40						
	240 = 2xM40						
	29 = PG29						
	229 = 2xPG29						
	36 = PG36						
	236 = 2xPG36						
	42 = PG42						

<b>Heavy Connector Serie HDD-144</b>
Part No.: <b>0945013</b>
Customer:

DRW:	Jason	CHKD	Wilson	MATL:	Wilson	TOLERANCE	Mason	DATE	16.08.2010
APPD:	Schumi			FINISH	Jamy		Sheet No.		2 from 2