

# EDCON-COMPONENTS



**Contact**



## SPECIFICATION:

Materials: Die-casting aluminium alloy  
 Color: Alloy  
 Interlocking Components: Stainless steel or galvanized steel button  
 Galvanized Steel: IP65  
 Temperatur Range: -40°C to +125°C  
 Flammability acc: VO (UL94)  
 Cable Entry: panel side  
 Lever: one Lever

## Technical Drawing

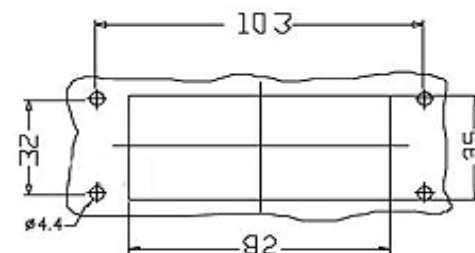
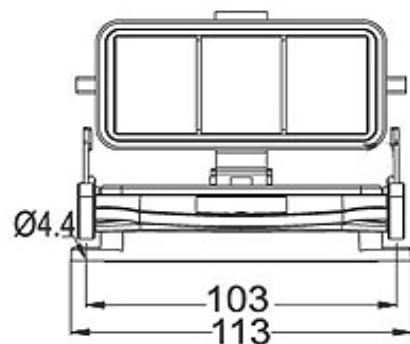
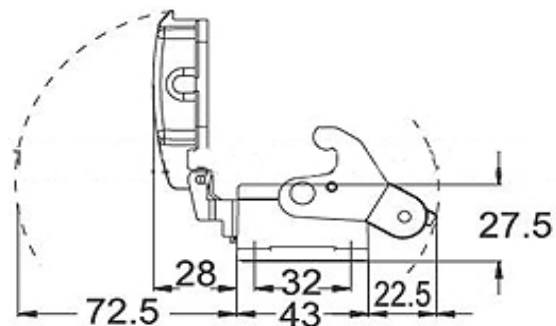

Panel cut out

**Heavy Connector Serie  
HDD-72**

Part No.: **0943017**

DRW:	Jason	CHKD	Wilson	MATL:	Wilson	TOLERANCE	Mason	DATE	16.08.2010
APPD:	Schumi			FINISH	Jamy		Sheet No.	1 from 2	Customer:

[www.edcon-components.com](http://www.edcon-components.com)

email: [info@edcon-components.com](mailto:info@edcon-components.com)

# EDCON-COMPONENTS



**Contact**



## Ordering Informations

Serie	Thread Type	Size of Thread	ROHS	Packing						
<b>0943017</b>	<b>X</b>	<b>XX</b>	<b>R</b>	<b>CA</b>						

<b>X=</b> No function	<b>XX=</b> No function	<b>R=</b> ROHS Conform	<b>CA=</b> Carton						
		<b>N=</b> NON ROHS Conform							

<b>Heavy Connector Serie HDD-72</b>
Part No.: <b>0943017</b>
Customer:

DRW:	Jason	CHKD	Wilson	MATL:	Wilson	TOLERANCE	Mason	DATE	16.08.2010
APPD:	Schumi			FINISH	Jamy			Sheet No.	2 from 2